



Programmable Controller

MELSEC *L* series

# MELSEC-L CC-Link IE Field Network Head Module User's Manual

---

-LJ72GF15-T2

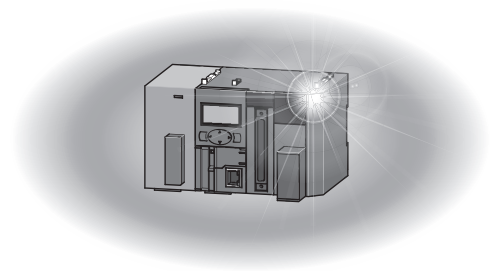



# ● SAFETY PRECAUTIONS ●

(Read these precautions before using this product.)

Before using this product, please read this manual and the relevant manuals carefully and pay full attention to safety to handle the product correctly.

In this manual, the safety precautions are classified into two levels: "⚠ WARNING" and "⚠ CAUTION".



Indicates that incorrect handling may cause hazardous conditions, resulting in death or severe injury.



Indicates that incorrect handling may cause hazardous conditions, resulting in minor or moderate injury or property damage.

Under some circumstances, failure to observe the precautions given under "⚠ CAUTION" may lead to serious consequences.

Observe the precautions of both levels because they are important for personal and system safety. Make sure that the end users read this manual and then keep the manual in a safe place for future reference.

## [Design Precautions]

### **WARNING**

- Configure safety circuits external to the programmable controller to ensure that the entire system operates safely even when a fault occurs in the external power supply or the programmable controller. Failure to do so may result in an accident due to an incorrect output or malfunction.
  - (1) Emergency stop circuits, protection circuits, and protective interlock circuits for conflicting operations (such as forward/reverse rotations or upper/lower limit positioning) must be configured external to the programmable controller.
  - (2) When the programmable controller detects an abnormal condition, it stops the operation and all outputs are:
    - Turned off if the overcurrent or overvoltage protection of the power supply module is activated.
    - Held or turned off according to the parameter setting if the self-diagnostic function of the head module detects an error such as a watchdog timer error.Also, all outputs may be turned on if an error occurs in a part, such as an I/O control part, where the head module cannot detect any error. To ensure safety operation in such a case, provide a safety mechanism or a fail-safe circuit external to the programmable controller. For a fail-safe circuit example, refer to Page 150, Appendix 10.
  - (3) Outputs may remain on or off due to a failure of a component such as a relay and transistor in an output circuit. Configure an external circuit for monitoring output signals that could cause a serious accident.
- In an output circuit, when a load current exceeding the rated current or an overcurrent caused by a load short-circuit flows for a long time, it may cause smoke and fire. To prevent this, configure an external safety circuit, such as a fuse.
- Configure a circuit so that the programmable controller is turned on first and then the external power supply. If the external power supply is turned on first, an accident may occur due to an incorrect output or malfunction.
- Configure a circuit so that the external power supply is turned off first and then the programmable controller. If the programmable controller is turned off first, an accident may occur due to an incorrect output or malfunction.
- For the operating status of each station after a communication failure, refer to relevant manuals for each network. Incorrect output or malfunction due to a communication failure may result in an accident.
- When changing data from a peripheral device connected to the head module during operation, configure an interlock circuit in the program of the master station to ensure that the entire system will always operate safely.

For other controls to a running programmable controller (such as modification of the master station program or operating status change), read relevant manuals carefully and ensure the safety before the operation. Especially, when a remote programmable controller is controlled by an external device, immediate action cannot be taken if a problem occurs in the programmable controller due to a communication failure. To prevent this, configure an interlock circuit in the program of the master station, and determine corrective actions to be taken between the external device and head module in case of a communication failure.
- Analog outputs may remain on due to a failure of the module. Configure an external interlock circuit for output signals that could cause a serious accident.

## [Design Precautions]

### **WARNING**

- Do not write any data to the "system area" and "write-protect area" (R) of the buffer memory in the intelligent function module. Also, do not use any "use prohibited" signals as an output signal from the head module to the intelligent function module. Doing so may cause malfunction of the programmable controller system.
- If a communication cable (such as a CC-Link dedicated cable) is disconnected, the network may be unstable, resulting in a communication failure of multiple stations. Configure an interlock circuit in the program to ensure that the entire system will always operate safely even if communications fail. Failure to do so may result in an accident due to an incorrect output or malfunction.

## [Design Precautions]

### **CAUTION**

- Do not install the control lines or communication cables together with the main circuit lines or power cables. Keep a distance of 100mm or more between them. Failure to do so may result in malfunction due to noise.
- During control of an inductive load such as a lamp, heater, or solenoid valve, a large current (approximately ten times greater than normal) may flow when the output is turned from off to on. Therefore, use a module that has a sufficient current rating.
- At power-on, a voltage may occur or a current may flow between output terminals of the analog output module for a moment. In this case, start the control after analog outputs become stable.

## [Installation Precautions]

### **WARNING**

- Shut off the external power supply (all phases) used in the system before mounting or removing a module. Failure to do so may result in electric shock or cause the module to fail or malfunction.

## [Installation Precautions]

### **CAUTION**

- Use the head module in an environment that meets the general specifications in this manual. Failure to do so may result in electric shock, fire, malfunction, or damage to or deterioration of the product.
- To interconnect modules, engage the respective connectors and securely lock the module joint levers until they click. Incorrect interconnection may cause malfunction, failure, or drop of the module.
- Tighten the screws within the specified torque range. Undertightening can cause drop of the screw, short circuit, or malfunction. Overtightening can damage the screw and/or module, resulting in drop, short circuit, or malfunction.
- Do not directly touch any conductive parts and electronic components of the module. Doing so can cause malfunction or failure of the module.

## [Wiring Precautions]

### **WARNING**

- Shut off the external power supply (all phases) used in the system before wiring. Failure to do so may result in electric shock or cause the module to fail or malfunction.
- After installation and wiring, attach the included terminal cover to the module before turning it on for operation. Failure to do so may result in electric shock.

## [Wiring Precautions]

### **CAUTION**

- Individually ground the FG terminal of the programmable controller with a ground resistance of 100Ω or less. Failure to do so may result in electric shock or malfunction.
- Use applicable solderless terminals and tighten them within the specified torque range. If any spade solderless terminal is used, it may be disconnected when a terminal block screw comes loose, resulting in failure.
- Check the rated voltage and terminal layout before wiring to the module, and connect the cables correctly. Connecting a power supply with a different voltage rating or incorrect wiring may cause a fire or failure.
- Connectors for external devices must be crimped or pressed with the tool specified by the manufacturer, or must be correctly soldered. Incomplete connections may cause short circuit, fire, or malfunction.
- Securely connect the connector to the module.
- Do not install the control lines or communication cables together with the main circuit lines or power cables. Keep a distance of 100mm or more between them. Failure to do so may result in malfunction due to noise.
- Place the cables in a duct or clamp them. If not, dangling cable may swing or inadvertently be pulled, resulting in damage to the module or cables or malfunction due to poor contact.
- Check the interface type and correctly connect the cable. Incorrect wiring (connecting the cable to an incorrect interface) may cause failure of the module and external device.
- Tighten the terminal block screws within the specified torque range. Undertightening can cause short circuit, fire, or malfunction. Overtightening can damage the screw and/or module, resulting in drop, short circuit, fire, or malfunction.
- When disconnecting the cable from the module, do not pull the cable by the cable part. For the cable with connector, hold the connector part of the cable. For the cable connected to the terminal block, loosen the terminal screw. Pulling the cable connected to the module may result in malfunction or damage to the module or cable.
- Prevent foreign matter such as dust or wire chips from entering the module. Such foreign matter can cause a fire, failure, or malfunction.
- A protective film is attached to the top of the module to prevent foreign matter, such as wire chips, from entering the module during wiring. Do not remove the film during wiring. Remove it for heat dissipation before system operation.

## [Wiring Precautions]

### CAUTION

- When connecting a CC-Link system master/local module to the head module, use CC-Link dedicated cables for the CC-Link system. If not, the performance of the CC-Link system is not guaranteed. For the station-to-station cable length and the maximum overall cable length, follow the specifications in the MELSEC-L CC-Link System Master/Local Module User's Manual. If not, normal data transmission is not guaranteed.
- When the high-speed counter module is connected to the head module, ground the shield cable on the encoder side (relay box). Always ground the FG and LG terminals to the protective ground conductor. Failure to do so may cause malfunction.
- Mitsubishi Electric programmable controllers must be installed in control panels. Connect the main power supply to the power supply module in the control panel through a relay terminal block. Wiring and replacement of a power supply module must be performed by qualified maintenance personnel with knowledge of protection against electric shock. For wiring methods, refer to the MELSEC-L CPU Module User's Manual (Hardware Design, Maintenance and Inspection).

## [Startup and Maintenance Precautions]

### WARNING

- Do not touch any terminal while power is on. Doing so will cause electric shock or malfunction.
- Shut off the external power supply (all phases) used in the system before cleaning the module or retightening the terminal block screws or connector screws. Failure to do so may result in electric shock.

## [Startup and Maintenance Precautions]

### CAUTION

- Before performing online operations (especially, program modification, forced output, and operating status change) for the running head module from the peripheral connected, read relevant manuals carefully and ensure the safety. Improper operation may damage machines or cause accidents.
- Do not disassemble or modify the module. Doing so may cause failure, malfunction, injury, or a fire.
- Use any radio communication device such as a cellular phone or PHS (Personal Handy-phone System) more than 25cm away in all directions from the programmable controller. Failure to do so may cause malfunction.
- Shut off the external power supply (all phases) used in the system before mounting or removing a module. Failure to do so may cause the module to fail or malfunction.
- Tighten the terminal block screws or connector screws within the specified torque range. Overtightening can damage the screw and/or module, resulting in drop, short circuit, or malfunction.
- After the first use of the product (module and terminal block), do not connect/disconnect the product more than 50 times (in accordance with IEC 61131-2). Exceeding the limit may cause malfunction.
- Before handling the module, touch a conducting object such as a grounded metal to discharge the static electricity from the human body. Failure to do so may cause the module to fail or malfunction.

## [Operating Precautions]

### CAUTION

- When changing data and operating status, and modifying program of the running programmable controller from an external device such as a personal computer connected to an intelligent function module, read relevant manuals carefully and ensure the safety before operation. Incorrect change or modification may cause system malfunction, damage to the machines, or accidents.
- Do not power off the programmable controller or reset the head module while the setting values in the buffer memory are being written to the flash ROM in the module connected to the head module. Doing so will make the data in the flash ROM undefined. The values need to be set in the buffer memory and written to the flash ROM again. Doing so also may cause malfunction or failure of the module.

## [Disposal Precautions]

### CAUTION

- When disposing of this product, treat it as industrial waste.



# ● CONDITIONS OF USE FOR THE PRODUCT ●

- (1) Mitsubishi programmable controller ("the PRODUCT") shall be used in conditions;
- i) where any problem, fault or failure occurring in the PRODUCT, if any, shall not lead to any major or serious accident; and
  - ii) where the backup and fail-safe function are systematically or automatically provided outside of the PRODUCT for the case of any problem, fault or failure occurring in the PRODUCT.
- (2) The PRODUCT has been designed and manufactured for the purpose of being used in general industries. MITSUBISHI SHALL HAVE NO RESPONSIBILITY OR LIABILITY (INCLUDING, BUT NOT LIMITED TO ANY AND ALL RESPONSIBILITY OR LIABILITY BASED ON CONTRACT, WARRANTY, TORT, PRODUCT LIABILITY) FOR ANY INJURY OR DEATH TO PERSONS OR LOSS OR DAMAGE TO PROPERTY CAUSED BY the PRODUCT THAT ARE OPERATED OR USED IN APPLICATION NOT INTENDED OR EXCLUDED BY INSTRUCTIONS, PRECAUTIONS, OR WARNING CONTAINED IN MITSUBISHI'S USER, INSTRUCTION AND/OR SAFETY MANUALS, TECHNICAL BULLETINS AND GUIDELINES FOR the PRODUCT.

("Prohibited Application")

Prohibited Applications include, but not limited to, the use of the PRODUCT in;

- Nuclear Power Plants and any other power plants operated by Power companies, and/or any other cases in which the public could be affected if any problem or fault occurs in the PRODUCT.
- Railway companies or Public service purposes, and/or any other cases in which establishment of a special quality assurance system is required by the Purchaser or End User.
- Aircraft or Aerospace, Medical applications, Train equipment, transport equipment such as Elevator and Escalator, Incineration and Fuel devices, Vehicles, Manned transportation, Equipment for Recreation and Amusement, and Safety devices, handling of Nuclear or Hazardous Materials or Chemicals, Mining and Drilling, and/or other applications where there is a significant risk of injury to the public or property.

Notwithstanding the above, restrictions Mitsubishi may in its sole discretion, authorize use of the PRODUCT in one or more of the Prohibited Applications, provided that the usage of the PRODUCT is limited only for the specific applications agreed to by Mitsubishi and provided further that no special quality assurance or fail-safe, redundant or other safety features which exceed the general specifications of the PRODUCTS are required. For details, please contact the Mitsubishi representative in your region.

# INTRODUCTION

---

Thank you for purchasing the Mitsubishi Electric MELSEC-L series programmable controllers. This manual describes the operating procedure, system configuration, parameter setting, functions, and troubleshooting of the CC-Link IE Field Network head module (hereafter abbreviated as head module).

Before using this product, please read this manual and the relevant manuals carefully and develop familiarity with the functions and performance of the MELSEC-L series programmable controller to handle the product correctly.

# RELEVANT MANUALS

## (1) CC-Link IE Field Network (relevant) manuals

When using the CC-Link IE Field Network for the first time, refer to the CC-Link IE Field Network Master/Local Module User's Manual first.

Manual name <manual number (model code)>	Description
MELSEC iQ-R Ethernet/CC-Link IE User's Manual (Startup) <SH-081256ENG, 13JX09>	Specifications, procedures before operation, system configuration, wiring, and communication examples of Ethernet, CC-Link IE Controller Network, and CC-Link IE Field Network
MELSEC iQ-R CC-Link IE Field Network User's Manual (Application) <SH-081259ENG, 13JX18>	Functions, parameter settings, programming, troubleshooting, I/O signals, and buffer memory of CC-Link IE Field Network
MELSEC-Q CC-Link IE Field Network Master/Local Module User's Manual <SH-080917ENG, 13JZ47>	Overview of the CC-Link IE Field Network, and specifications, procedures before operation, system configuration, installation, wiring, settings, functions, programming, and troubleshooting of the CC-Link IE Field Network master/local module
MELSEC-L CC-Link IE Field Network Master/Local Module User's Manual <SH-080972ENG, 13JZ54>	Overview of the CC-Link IE Field Network, and specifications, procedures before operation, system configuration, installation, wiring, settings, functions, programming, and troubleshooting of the CC-Link IE Field Network master/local module
MELSEC-QS CC-Link IE Field Network Master/Local Module User's Manual <SH-080969ENG, 13JZ53>	Overview of the CC-Link IE Field Network, and specifications, procedures before operation, system configuration, installation, wiring, settings, functions, programming, and troubleshooting of the MELSEC-QS series master/local module
CC-Link IE Field Network Interface Board User's Manual (For SW1DNC-CCIEF-B) <SH-080980ENG, 13JZ58>	Specifications, procedures before operation, system configuration, settings, functions, programming, and troubleshooting of the CC-Link IE Field Network interface board

## (2) Operating manual

Manual name <manual number (model code)>	Description
GX Works2 Version 1 Operating Manual (Common) <SH-080779ENG, 13JU63>	System configuration, parameter settings, and online operations of GX Works2, which are common to Simple projects and Structured projects

# CONTENTS

SAFETY PRECAUTIONS .....	1
CONDITIONS OF USE FOR THE PRODUCT .....	7
INTRODUCTION .....	8
RELEVANT MANUALS .....	9
MANUAL PAGE ORGANIZATION .....	13
TERMS .....	14
PACKING LIST .....	16
<hr/>	
<b>CHAPTER 1 OVERVIEW</b>	<b>17</b>
<hr/>	
<b>CHAPTER 2 PART NAMES</b>	<b>20</b>
<hr/>	
<b>CHAPTER 3 SPECIFICATIONS</b>	<b>24</b>
<hr/>	
3.1 General Specifications .....	24
3.2 Performance Specifications .....	26
3.3 Function List .....	28
<hr/>	
<b>CHAPTER 4 PROCEDURES BEFORE OPERATION</b>	<b>29</b>
<hr/>	
4.1 Initial Start-up Procedure .....	29
4.2 Procedure for Replacing the Head Module .....	31
<hr/>	
<b>CHAPTER 5 SYSTEM CONFIGURATION</b>	<b>34</b>
<hr/>	
5.1 Head Module System Configuration .....	34
5.2 Applicable System .....	35
<hr/>	
<b>CHAPTER 6 INSTALLATION AND WIRING</b>	<b>36</b>
<hr/>	
6.1 Wiring Environment and Installation Position .....	36
6.1.1 Installation environment .....	36
6.1.2 Installation position .....	36
6.2 Installation .....	37
6.2.1 Connecting modules .....	38
6.2.2 Mounting the modules on a DIN rail .....	40
6.2.3 Changing modules on a DIN rail .....	43
6.3 Wiring to the Power Supply Module .....	45
6.4 Testing the Head Module Before Wiring .....	45
6.5 Wiring to the Head Module .....	47
6.5.1 Wiring .....	47
6.5.2 Grounding .....	49
6.5.3 Precautions .....	50
<hr/>	
<b>CHAPTER 7 PARAMETER SETTINGS</b>	<b>51</b>
<hr/>	
7.1 PLC Parameters .....	52
7.2 Network Parameters .....	62

7.3	Remote Password .....	63
7.4	Intelligent Function Module Parameters .....	64
<hr/> <b>CHAPTER 8 CYCLIC TRANSMISSION</b>		<b>65</b>
8.1	Cyclic Transmission of Bit Device Data .....	65
8.2	Cyclic Transmission of Word Device Data .....	71
<hr/> <b>CHAPTER 9 CC-LINK IE FIELD NETWORK DIAGNOSTICS</b>		<b>75</b>
9.1	Diagnostic Items .....	75
9.2	Starting Diagnostics .....	76
9.3	Diagnostic Window .....	78
9.4	Communication Test .....	80
9.5	Cable Test .....	80
9.6	System Monitor .....	81
9.7	Remote Operation .....	81
<hr/> <b>CHAPTER 10 MAINTENANCE AND INSPECTION</b>		<b>82</b>
10.1	Daily Inspection .....	82
10.2	Periodic Inspection .....	83
<hr/> <b>CHAPTER 11 TROUBLESHOOTING</b>		<b>84</b>
11.1	Before Troubleshooting .....	84
11.2	Troubleshooting Procedure .....	84
11.3	System Error History .....	89
11.4	Checking the LEDs .....	91
11.5	Troubleshooting by Symptom .....	95
11.5.1	When cyclic transmission cannot be performed .....	95
11.5.2	When transient transmission cannot be performed .....	95
11.6	List of Error Codes .....	96
<hr/> <b>APPENDICES</b>		<b>111</b>
Appendix 1	External Input/Output Forced On/Off .....	111
Appendix 2	File Password 32 .....	114
Appendix 2.1	Setting file passwords .....	115
Appendix 2.2	Password authentication method .....	119
Appendix 3	END Cover .....	121
Appendix 4	Link Special Relay (SB) .....	122
Appendix 5	Link Special Register (SW) .....	123
Appendix 6	Special Relay (SM) .....	126
Appendix 7	Special Register (SD) .....	128
Appendix 8	Access Code and Attribute Code .....	136
Appendix 9	EMC and Low Voltage Directives .....	137
Appendix 9.1	Measures to comply with the EMC Directive .....	137

Appendix 9.2 Measures to comply with the Low Voltage Directive .....	148
Appendix 10 General Safety Requirements .....	150
Appendix 11 Calculating Heating Value of Programmable Controller .....	151
Appendix 11.1 Calculating the average power consumption .....	151
Appendix 12 Processing Time .....	153
Appendix 13 Added and Changed Functions .....	154
Appendix 14 Checking Serial Number and Function Version .....	155
Appendix 15 External Dimensions .....	157

---

<b>INDEX</b> .....	<b>158</b>
REVISIONS .....	160
WARRANTY .....	161
TRADEMARKS .....	162

# MANUAL PAGE ORGANIZATION

In this manual, pages are organized and the symbols are used as shown below.

The following illustration is for explanation purpose only, and should not be referred to as an actual documentation.

The diagram illustrates the organization of a manual page, showing various symbols and their functions. The page content includes a chapter title 'CHAPTER 7 VARIOUS SETTINGS', a section title '7.1.1 Setting method', and a procedure '(1) Setting parameters' with sub-section '(a) Operating procedure'. The procedure includes two steps: '1. Open the "PLC Parameter" dialog box.' and '2. Select the "IO Assignment" tab.' An image of the 'PLC Parameter' dialog box is shown. Below the procedure is a table with columns 'Item', 'Description', and 'Reference'. The table lists items like 'Type', 'Model Name', 'Points', and 'Start XY' with their respective descriptions and references. There are also 'Example' (Ex.), 'Point', and 'Remark' sections. Annotations on the left explain symbols: '"" is used for screen names and items.', '1.' shows operating procedures, a mouse icon shows mouse operations, '[ ]' is used for items in the menu bar and the project window, 'Ex.' shows setting or operating examples, a book icon shows reference manuals, and a hand icon shows reference pages. Annotations on the right explain: 'The chapter of the current page is shown.', 'The section of the current page is shown.', 'Point shows notes that requires attention.', and 'Remark shows useful information.'

\*1 The mouse operation example (for GX Works2) is provided below.



The screenshot shows the MELSOFT Series GX Works2 software interface. The menu bar at the top includes 'Project', 'Edit', 'Find/Replace', 'Compile', 'View', 'Online', 'Debug', and 'Diagnose'. The 'Project' menu is open, showing options like 'Project', 'Parameter', 'Intelligent Function Module', 'Global Device Comment', 'Program Setting', 'POU', 'Program', 'MAIN', 'Local Device Comment', 'Device Memory', and 'Device Initial Value'. The 'Navigation' pane on the left shows a tree view with 'Project' selected. The main workspace shows a ladder logic diagram. Annotations on the left explain: 'Menu bar' points to the top menu, 'Ex.' shows a mouse operation on the 'Project' menu bar, 'A window selected in the view selection area is displayed.' points to the 'Project' window in the navigation pane, and 'View selection area' points to the bottom of the navigation pane.

# TERMS

Unless otherwise specified, this manual uses the following terms.

Term	Description
Buffer memory	A memory in an intelligent function module, where data (such as setting values and monitoring values) are stored
CC-Link	A field network system where data processing for control and information can be simultaneously performed at high speed
CC-Link IE Field Network	A high-speed and large-capacity open field network that is based on Ethernet (1000BASE-T)
Cyclic transmission	A function by which data are periodically exchanged among stations on the same network using link devices (RX, RY, RWw, and RWr)
Data link	A generic term for cyclic transmission and transient transmission
Dedicated instruction	An instruction that simplifies programming for using functions of intelligent function modules
Device	A device (X, Y, W, or others) in a head module
Disconnection	A process of stopping data link if a data link error occurs
GX Works2	The product name of the software package for the MELSEC programmable controllers
Head module	The abbreviation for the LJ72GF15-T2 CC-Link IE Field Network head module
Intelligent device station	A station that exchanges I/O signals (bit data) and I/O data (word data) with the master station by cyclic transmission. This station responds to a transient transmission request from another station and also issues a transient transmission request to another station.
Intelligent function module	A module that has functions other than input and output, such as an A/D converter module and D/A converter module
Link dedicated instruction	A dedicated instruction used for transient transmission with a programmable controller on another station. This instruction allows a master/local module to communicate with programmable controllers on the same network (CC-Link IE Field Network) and on other networks (Ethernet, CC-Link IE Controller Network, and MELSECNET/H). In addition to CC-Link IE Field Network, Ethernet, CC-Link IE Controller Network, and MELSECNET/H are also accessible.
Link device	A device (RX, RY, RWr, or RWw) in a module on CC-Link IE Field Network
Link special register (SW)	Word data that indicates the operating status and data link status of a module on CC-Link IE Field Network
Link special relay (SB)	Bit data that indicates the operating status and data link status of a module on CC-Link IE Field Network
Local station	A station that performs cyclic transmission and transient transmission with the master station and other local stations. The station is controlled by programs in the CPU module or other equivalent modules on the station.
Master station	A station that controls the entire network. This station can perform cyclic transmission and transient transmission with all stations. Only one master station can be used in a network.
Master/local module	A generic term for the RJ71GF11-T2, QJ71GF11-T2, QS0J71GF11-T2, LJ71GF11-T2 CC-Link IE Field Network master/local module and the following modules when the CC-Link IE Field Network function is used: <ul style="list-style-type: none"> <li>• RJ71EN71</li> <li>• RnENCPU</li> </ul>
Network module	A generic term for the following modules: <ul style="list-style-type: none"> <li>• CC-Link IE Field Network module</li> <li>• CC-Link IE Controller Network module</li> <li>• Ethernet interface module</li> <li>• MELSECNET/H module</li> <li>• MELSECNET/10 module</li> </ul>
Parameter memory	A flash ROM in a head module, where the parameters of the head module are stored
Programming tool	Another term for GX Works2
RAS	The abbreviation for Reliability, Availability, and Serviceability. This term refers to usability of automated equipment.
Relay station	A station that includes two or more network modules. Data are passed through this station to stations on other networks
Remote device station	A station that exchanges I/O signals (bit data) and I/O data (word data) with the master station by cyclic transmission. This station responds to a transient transmission request from another station.
Remote I/O station	A station that exchanges I/O signals (bit data) with the master station by cyclic transmission
Remote input (RX)	Bit data input from a slave station to the master station (For some areas in a local station, data are input in the opposite direction.)  User's manual for the master/local module used



Term	Description
Remote output (RY)	<p>Bit data output from the master station to a slave station (For some areas in a local station, data are output in the opposite direction.)</p> <p> User's manual for the master/local module used</p>
Remote register (RWr)	<p>Word data input from a slave station to the master station (For some areas in a local station, data are input in the opposite direction.)</p> <p> User's manual for the master/local module used</p>
Remote register (RWw)	<p>Word data output from the master station to a slave station (For some areas in a local station, data are output in the opposite direction.)</p> <p> User's manual for the master/local module used</p>
Reserved station	A station reserved for future use. This station is not actually connected, but counted as a connected station
Return	A process of restarting data link when a station recovers from an error
RIRD	<p>The abbreviation for JP.RIRD and GP.RIRD.</p> <p>This dedicated instruction is used in programs of the master/local module.</p>
RIWT	<p>The abbreviation for JP.RIWT and GP.RIWT.</p> <p>This dedicated instruction is used in programs of the master/local module.</p>
Routing	<p>A process of selecting paths for communication with other networks.</p> <p>CC-Link IE Field Network requires communication paths to be preset using routing parameters to communicate with stations on different networks.</p> <p>A head module does not require routing parameters. Communications with other networks are performed according to the routing parameters set to the master station.</p>
Slave station	A generic term for stations other than a master station: local station, remote I/O station, remote device station, and intelligent device station
Transient transmission	A function of communication with another station, which is used when requested by a dedicated instruction or GX Works2

# PACKING LIST

---

The following items are included in the package of this product. Before use, check that all the items are included.

---

## LJ72GF15-T2

---

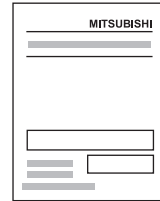
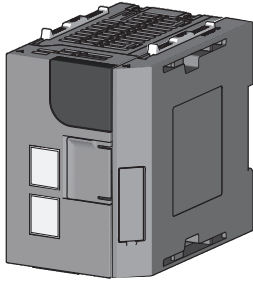

Head module (LJ72GF15-T2) + END cover (L6EC)

Safety Guidelines (IB(NA)-0800455)

---

# CHAPTER 1 OVERVIEW

The head module can connect MELSEC-L series I/O modules and intelligent function modules on CC-Link IE Field Network.

The head module can be used as an intelligent device station on the CC-Link IE Field Network system.

For CC-Link IE Field Network, refer to the following.

 User's manual for the master/local module used

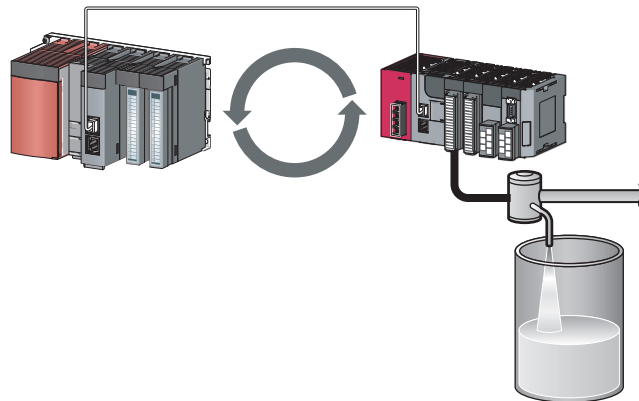

## (1) Cyclic transmission

The I/O signals of the module connected to the head module can operate as those of the master station by performing cyclic transmission. (☞ Page 65, CHAPTER 8)

For example, when the output (Y) of the master station turns on, the output (Y) of the module connected to the head module turns on.

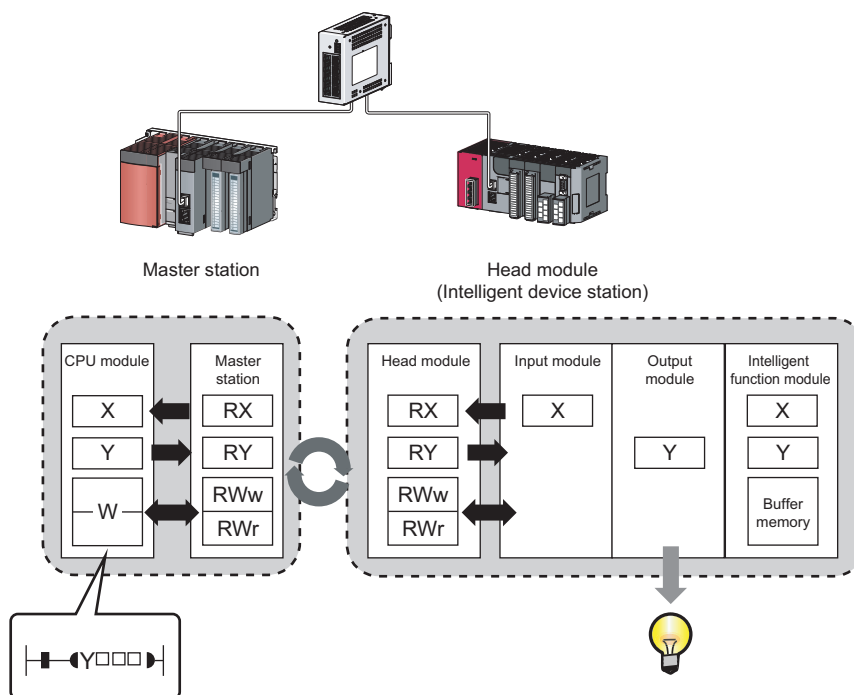

## (2) Transient transmission

The master station and a local station can directly access the devices in the head module and the buffer memory in the connected intelligent function module by performing transient transmission. Communications with other stations on other networks can also be performed.

The master station and a local station send requests to the head module by using dedicated instructions. (  User's manual for the master/local module used)

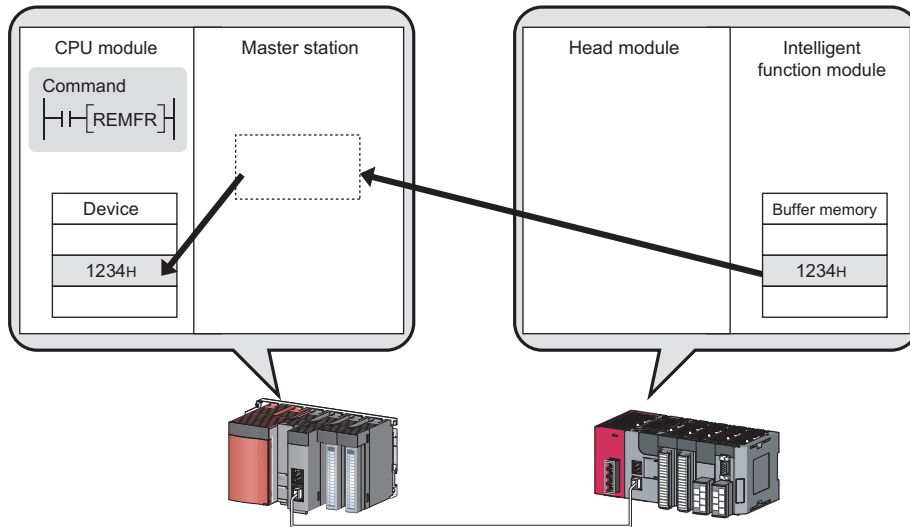

## (3) Parameter settings

Parameters for the head module can be set using GX Works2. Creating a program for setting parameters is not required. (  Page 51, CHAPTER 7)

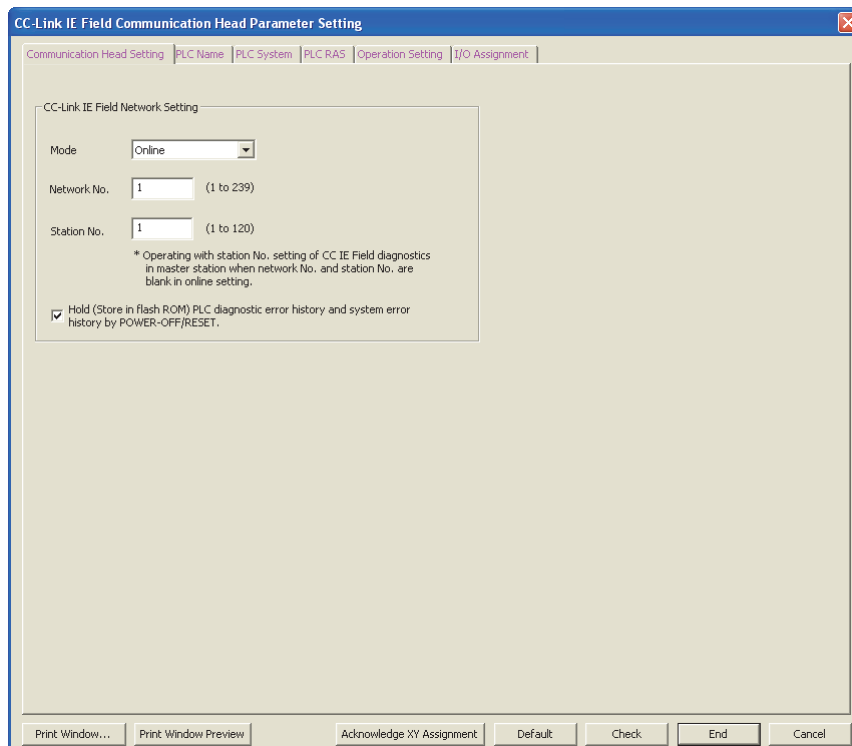

### (4) Diagnostics

Diagnostics of the head module and connected modules can be performed using GX Works2. (☞ Page 75, CHAPTER 9, Page 84, Section 11.2)

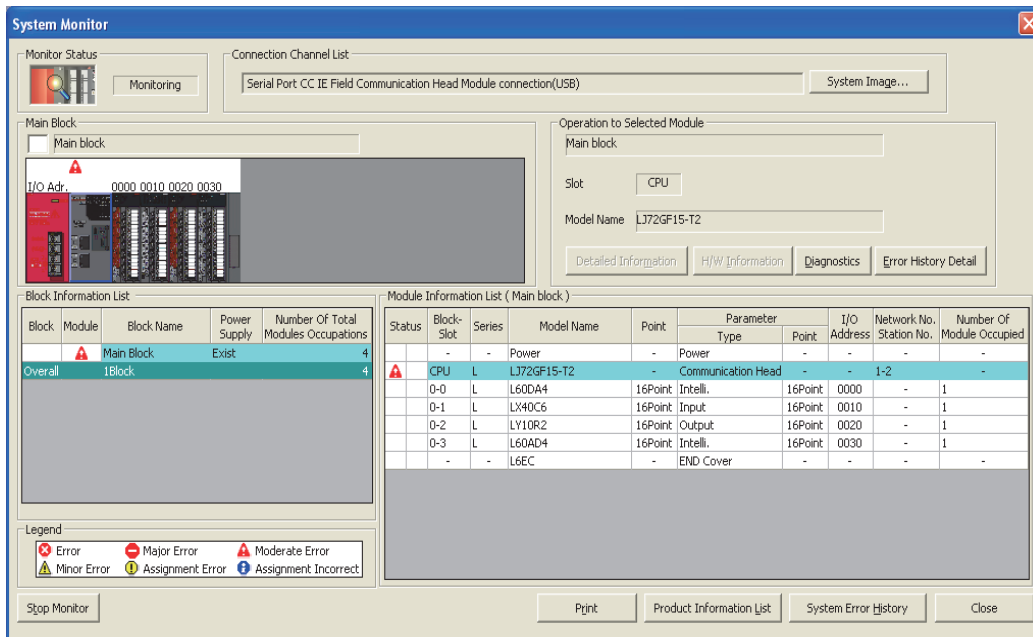

# CHAPTER 2 PART NAMES

This chapter describes the part names of the head module.

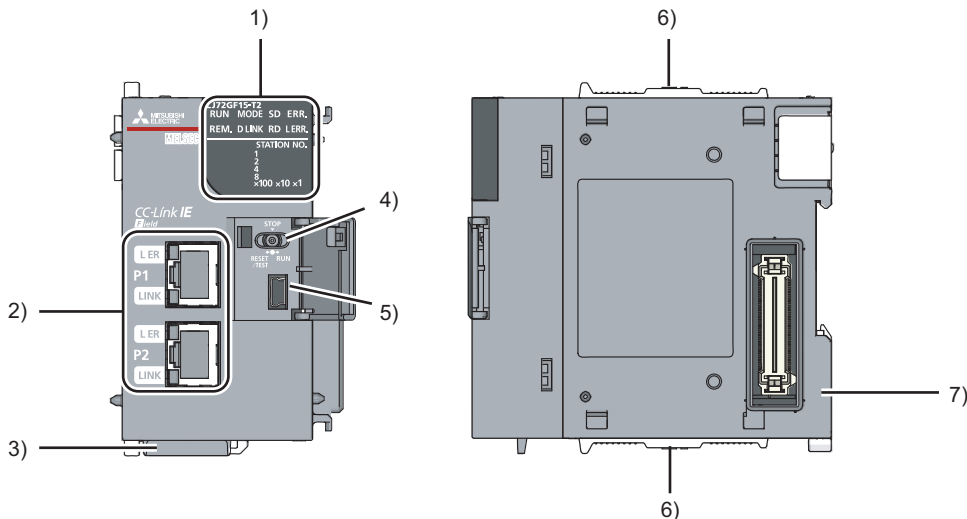

No.	Name	Description	
1)	RUN LED	—	Indicates the operating status.
		On	Operating normally. (RUN state)
		Flashing	Operating normally. (STOP state) <ul style="list-style-type: none"> <li>The switch of the head module is set to STOP. (Data transfer between the devices in the head module is stopped.)</li> <li>The master station is in the STOP state. (Data transfer between the devices in the head module is continued.)</li> <li>Accepting remote STOP request</li> <li>The head module has stopped due to an error (except a watchdog timer error).</li> </ul>
		Off	A hardware failure or a watchdog timer error has occurred.
	MODE LED	—	Indicates the mode.
		On	Online mode
		Flashing	Test mode
	REM. LED	Off	Offline mode
		—	Indicates the operating status of the own station.
		On	Operating normally.
	D LINK LED	Flashing	The own station has not been reset after writing data to the CPU module. Or, forced input/output is being registered.
		Off	The initial data are being processed, or an error has occurred in the own station.
—		Indicates the data link status.	
SD LED	On	Data link (cyclic transmission being performed)	
	Flashing	Data link (cyclic transmission stopped)	
	Off	Data link not in operation (disconnected) or offline mode	
RD LED	—	Indicates the data sending status.	
	On	Data being sent	
RD LED	Off	Data not sent	
	—	Indicates the data receiving status.	
RD LED	On	Data being received	
	Off	Data not received	

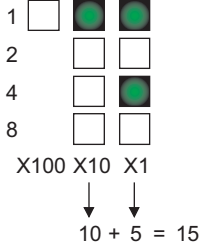
No.	Name	Description		
1)	ERR. LED	—	Indicates the error status of the head module. The error details can be checked by performing the CC-Link IE Field Network diagnostics. (☞ Page 75, CHAPTER 9)	
		On	An error has occurred in the head module.	
		Off	Operating normally.	
	L ERR. LED	—	Indicates the receive data and line error status. When this LED is on, the port in which the error was detected can be checked with the L ER LED of "P1" or "P2". The error details can be checked by performing the CC-Link IE Field Network diagnostics. (☞ Page 75, CHAPTER 9) This LED automatically turns off when the module has received normal data or does not perform loopback in ring topology.	
		On	<ul style="list-style-type: none"> <li>The module has received abnormal data.</li> <li>The module is performing loopback. (Only for the head module with a serial number (first five digits) of "12072" or later)</li> </ul>	
		Off	<ul style="list-style-type: none"> <li>The module has received normal data.</li> <li>The module does not perform loopback. (Only for the head module with a serial number (first five digits) of "12072" or later)</li> </ul>	
	STATION NO.	—	Displays the station number of the head module.	
		On	Displays the station number. Example: Station number 15  $10 + 5 = 15$	
		Off	The station number has not been set.	
	2)	P1	—	PORT1 connector for CC-Link IE Field Network (RJ45 connector) An Ethernet cable is connected here. (☞ Page 47, Section 6.5.1) There is no restriction on the order of connecting the "P1" and "P2" connectors.
L ER LED			On	<ul style="list-style-type: none"> <li>The module has received abnormal data.</li> <li>The module is performing loopback. (Only for the head module with a serial number (first five digits) of "12072" or later)</li> </ul>
			Off	<ul style="list-style-type: none"> <li>The module has received normal data.</li> <li>The module does not perform loopback. (Only for the head module with a serial number (first five digits) of "12072" or later)</li> </ul>
LINK LED			On	Link-up
		Off	Link-down	
P2		—	PORT2 connector for CC-Link IE Field Network (RJ45 connector) An Ethernet cable is connected here. (☞ Page 47, Section 6.5.1) There is no restriction on the order of connecting the "P1" and "P2" connectors.	
		L ER LED	(Same as the "P1" connector)	
	LINK LED	(Same as the "P1" connector)		
3)	Serial number display	Displays the serial number printed on the rating plate.		

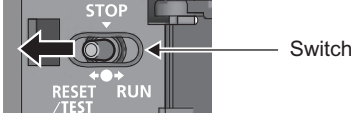
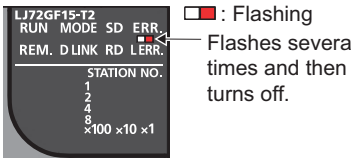
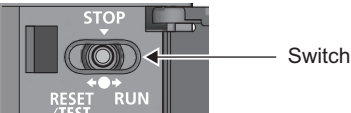
No.	Name	Description
4)	Switch	<p>Controls the operation of the head module.</p> <hr/> <p>Resets the head module or switches it to test mode. Operate the switch with your fingers. Use of a tool such as a screw driver may damage the switch.</p> <ul style="list-style-type: none"> <li>Reset method</li> </ul> <p><b>1. Hold the switch in the RESET/TEST position for 1 second or more.</b></p> <p>Do not release your hand from the switch while it is in the RESET/TEST position.</p>  <p><b>2. Check that the ERR. LED flashes several times and then turns off.</b></p>  <p><b>3. Set the switch to the STOP position.</b></p> <p>The switch automatically returns to the STOP position when your hand is released.</p>  <ul style="list-style-type: none"> <li>Test method</li> </ul> <p>For details on the test mode, refer to the following. (☞ Page 45, Section 6.4)</p>
		<p>STOP*1</p> <p>Stops the data transfer between the link devices (cyclic data from the master station) of the head module and the devices in the head module. (Stops the transfer while performing cyclic transmission with the master station, and turns the output off.) By stopping the data transfer, the input/output of the module connected to the head module are not sent to the master or local station. The STOP switch is used to perform a debug operation between modules connected to the head module and external devices. The following shows an example of a debug method with external devices using the STOP switch.</p> <ol style="list-style-type: none"> <li>Set the switch to "STOP".</li> <li>Data transfer is stopped between the link devices of the head module and the devices in the head module, and the devices are separated from the master station control.</li> <li>Perform an input/output test between the module connected to the head module and the external device. Since the data transfer is stopped, the input/output status data are not sent to the master or local station.</li> <li>Upon completion of the test, data are written to the head module and the system operation starts.</li> </ol>
		<p>RUN</p> <p>Starts the data transfer between the link devices (cyclic data from the master station) of the head module and the devices in the head module. The output from the master station is output from the module connected to the head module. The input from the module connected to the head module is input to the master station.</p>
5)	USB connector	A connector for connecting GX Works2 (Connector type: miniB)
6)	Module joint levers	Levers for connecting modules each other
7)	DIN rail hook	A hook used to mount the module to a DIN rail

\*1 Even if the switch is set to "STOP", the master station will indicate that a cyclic transmission is being performed in the head module.



**Remark**

- Opening and closing the front cover of the head module  
The cover on the front of the head module is equipped with a stopper. If you open the cover until it clicks, it will stay open.

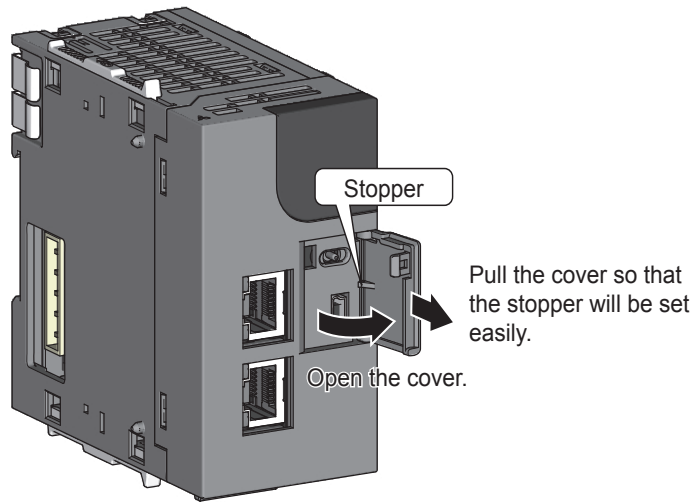

- LED indication during a line test  
The following LEDs flash while a line test is performed from the master station.
  - MODE LED
  - D LINK LED
  - ×100 LED

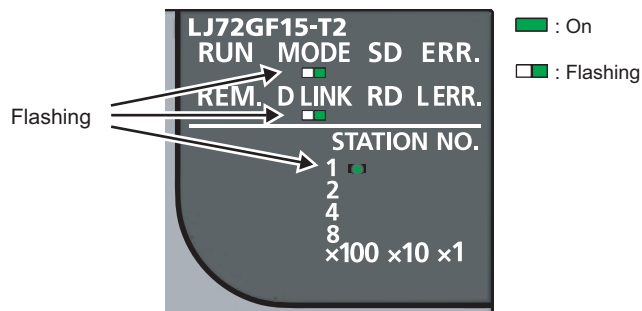

For information on how to perform a line test, refer to the following.

User's manual for the master/local module used

# CHAPTER 3 SPECIFICATIONS

This chapter describes the specifications of the head module.

## 3.1 General Specifications

Item	Specifications					
Operating ambient temperature	0 to 55°C					
Storage ambient temperature	-25 to 75°C					
Operating ambient humidity	5 to 95%RH, non-condensing					
Storage ambient humidity						
Vibration resistance	Compliant with JIS B 3502 and IEC 61131-2	Under intermittent vibration	Frequency	Constant acceleration	Half amplitude	Sweep count
			5 to 8.4Hz	—	3.5mm	10 times each in X, Y, and Z directions
		Under continuous vibration	8.4 to 150Hz	9.8m/s <sup>2</sup>	—	
			5 to 8.4Hz	—	1.75mm	—
8.4 to 150Hz	4.9m/s <sup>2</sup>	—				
Shock resistance	Compliant with JIS B 3502 and IEC 61131-2 (147m/s <sup>2</sup> , 3 times each in X, Y, and Z directions)					
Operating atmosphere	No corrosive gases					
Operating altitude*1	0 to 2000m					
Installation location	Inside a control panel					
Overvoltage category*2	II or less					
Pollution degree*3	2 or less					
Equipment class	Class I					

- \*1 Do not use or store the programmable controller under pressure higher than the atmospheric pressure of altitude 0m. Doing so may cause malfunction. When using the programmable controller under pressure, please consult your local Mitsubishi representative.
- \*2 This indicates the section of the power supply to which the equipment is assumed to be connected between the public electrical power distribution network and the machinery within premises.  
Category II applies to equipment for which electrical power is supplied from fixed facilities. The surge voltage withstand level for up to the rated voltage of 300V is 2500V.
- \*3 This index indicates the degree to which conductive material is generated in terms of the environment in which the equipment is used.  
Pollution degree 2 is when only non-conductive pollution occurs. A temporary conductivity caused by condensing must be expected occasionally.

**Point** 



---

To make the programmable controller comply with the EMC and Low Voltage Directives, refer to  Page 137, Appendix 9.

---

## 3.2 Performance Specifications

For the specifications of the entire CC-Link IE Field Network, refer to the user's manual for the master/local module used.

Item		Specifications	
CC-Link IE Field Network part	Maximum number of link points per station	RWw	1024 points, 2K bytes
		RWr	1024 points, 2K bytes
		RX	2048 points, 256 bytes
		RY	2048 points, 256 bytes
	Station type		Intelligent device station
	Station number		1 to 120
	Network number		1 to 239
Ethernet part	Communication speed		1Gbps
	Network topology		Line topology, star topology, and ring topology (Coexistence of line topology and star topology is also possible.)
	Connection cable		Ethernet cable that satisfies 1000BASE-T standard: Category 5e or higher, straight cable (double shielded, STP) (  User's manual for the master/local module used)
	Maximum station-to-station distance		100m (conforms to ANSI/TIA/EIA-568-B (Category 5e)) (  Page 50, Section 6.5.3 (5))
	Overall cable distance		Line topology: 12000m (when 1 master station and 120 slave stations are connected) Star topology: Depends on the system configuration. Ring topology: 12100m (when 1 master station and 120 slave stations are connected)
	Number of cascade connections		20 levels maximum

Item		Specifications	
Head module part	Number of I/O points	X	4096 points, 512 bytes (Number of points accessible to the actual module)*1
		Y	4096 points, 512 bytes (Number of points accessible to the actual module)*1
	Number of device points	X	8192 points, 1K bytes (Number of points can be used in the program) (Assign RX0 from X0.)
		Y	8192 points, 1K bytes (Number of points can be used in the program) (Assign RY0 from Y0.)
		W	8192 points, 16K bytes (Assign 1024 points (W0 to W3FF) from RWw0. Assign 1024 points (W1000 to W13FF) from RWr0.)
		SB	8192 points, 1K bytes (SB0000 to SB0FFF are used by the system. SB1000 to SB1FFF can be modified by the user.)
		SW	8192 points, 16K bytes (SW0000 to SW0FFF are used by the system. SW1000 to SW1FFF can be modified by the user.)
		SM	2048 points, 256 bytes
		SD	2048 points, 4K bytes
		U□□\G□□	Device that directly accesses the buffer memory of the intelligent function module (  User's manual for the intelligent function module used)
	Number of writes to the parameter memory		100000 times maximum
	Maximum number of intelligent function module parameters	Initial setting	4096
		Auto refresh	2048
	Allowable momentary power failure time		Depends on the power supply module used.
	Internal current consumption (5VDC)		1.0A
	External dimensions	H	90mm
W		50mm	
D		95mm	
Weight		0.23kg	

\*1 This is the maximum number of points that can be assigned to the actual module in the "I/O Assignment" setting of PLC parameter using GX Works2.

## 3.3 Function List

The following table lists the functions of the head module.

Function	Description	Reference
Cyclic transmission	The input and output data of the modules connected to the head module can be used just like those of the master station.	Page 65, CHAPTER 8
Transient transmission	The master station and a local station can directly access the devices in the head module and the buffer memory in an intelligent function module. Communications with other stations on other networks can also be performed.  The master station and a local station send requests to the head module by using dedicated instructions. (  User's manual for the master/local module used)	Manual for the master/local module
Error time output mode	Specifies whether to clear or hold the output to each module when a stop error or a data link error occurs in the head module.	Page 61, Section 7.1 (6)
PLC operation mode at H/W error	Select whether to stop auto refresh of the head module when a hardware failure occurs in an intelligent function module (when the head module detects SP.UNIT DOWN).	Page 61, Section 7.1 (6)
File password 32	Sets write password and read password for each file stored in the head module.	Page 114, Appendix 2
Remote password	Prevents unauthorized access from external devices, using a serial communication module connected to the head module.	Page 63, Section 7.3
Diagnostics	Performs diagnostics of the head module and connected modules using GX Works2.	Page 75, CHAPTER 9 Page 84, Section 11.2
System error history	Checks the error history of both the head module and intelligent function modules in one single window.	Page 89, Section 11.3
Remote RUN/STOP	Changes the status of the head module to RUN or STOP, without using the switch.	Page 81, Section 9.7
Remote RESET	Resets the head module when it is in the STOP status, without using the switch.	Page 81, Section 9.7
Monitoring/test	Monitors the status and changes the current values of the devices in the head module and the buffer memory in the connected intelligent function module using GX Works2. Use one of the following to monitor the status or change the current values. <ul style="list-style-type: none"> <li>• Device/buffer memory batch monitor</li> <li>• Watch window</li> <li>• Present value change</li> </ul>	GX Works2 operating manual
External input/output forced on/off	Forcibly turns on or off the external input/output of the head module.	Page 111, Appendix 1
Station number setting from the master station	Set a station number of the head module from the CC-Link IE Field Network diagnostics of the master station.	Page 31, Section 4.2

# CHAPTER 4 PROCEDURES BEFORE OPERATION

This chapter describes the procedures before operating the head module.

## 4.1 Initial Start-up Procedure

The following is the start-up procedure for using the head module for the first time.

For start-up examples, refer to the  User's manual for the master/local module used.

Check box

### System consideration

Consider the system configuration and link device assignments.



Page 34, CHAPTER 5,  
Page 65, CHAPTER 8



### Installation

Install the power supply module, head module, I/O module(s), intelligent function module(s), and an END cover.



Page 36, Section 6.1,  
Page 37, Section 6.2,  
Page 45, Section 6.3



### Unit test

Perform unit tests on the head module and intelligent function module(s).



Page 45, Section 6.4



### Connection

Connect Ethernet cables to the head module.



Page 47, Section 6.5



### Configuration

Set parameters for each module.



Page 51, CHAPTER 7,  
Page 65, CHAPTER 8





### Starting data link

Start data link.



Page 20, CHAPTER 2  
Page 65, CHAPTER 8



### Network diagnostics

Check if the network can communicate normally by using CC-Link IE field network diagnostics.



Page 75, CHAPTER 9

## **Point**

---

If the head module is powered on when there is no communication with the master station, it takes approximately five seconds to change to the RUN state.

---



## 4.2 Procedure for Replacing the Head Module

The head module can be replaced without stopping the data link in the system.

Even if the head module does not have a station number, it can be set from the CC-Link IE Field Network diagnostics of the master station.

### (1) Procedure

Check box

#### Link stop and temporary error invalid station setting

Stop the link at the master station, and set the intelligent device station to be replaced as a temporary error invalid station.



User's manual for the master/local module used



#### Cable disconnection

Turn off the power, and disconnect the Ethernet cables from the head module.



Page 47, Section 6.5



#### Head module replacement

Replace the head module.



Page 43, Section 6.2.3



#### Cable connection

Connect Ethernet cables to the head module, and power it on.



Page 47, Section 6.5



#### Station No. setting

Set a unique station No. for the head module so that duplication will not be detected in CC-Link IE field network diagnostics from the master station.



Page 33, Section 4.2 (3)





#### Parameter setting

Change the connection destination of GX Works to the head module, and set the network No., station No. and the parameter of each module.



Page 51, CHAPTER 7,  
Page 65, CHAPTER 8

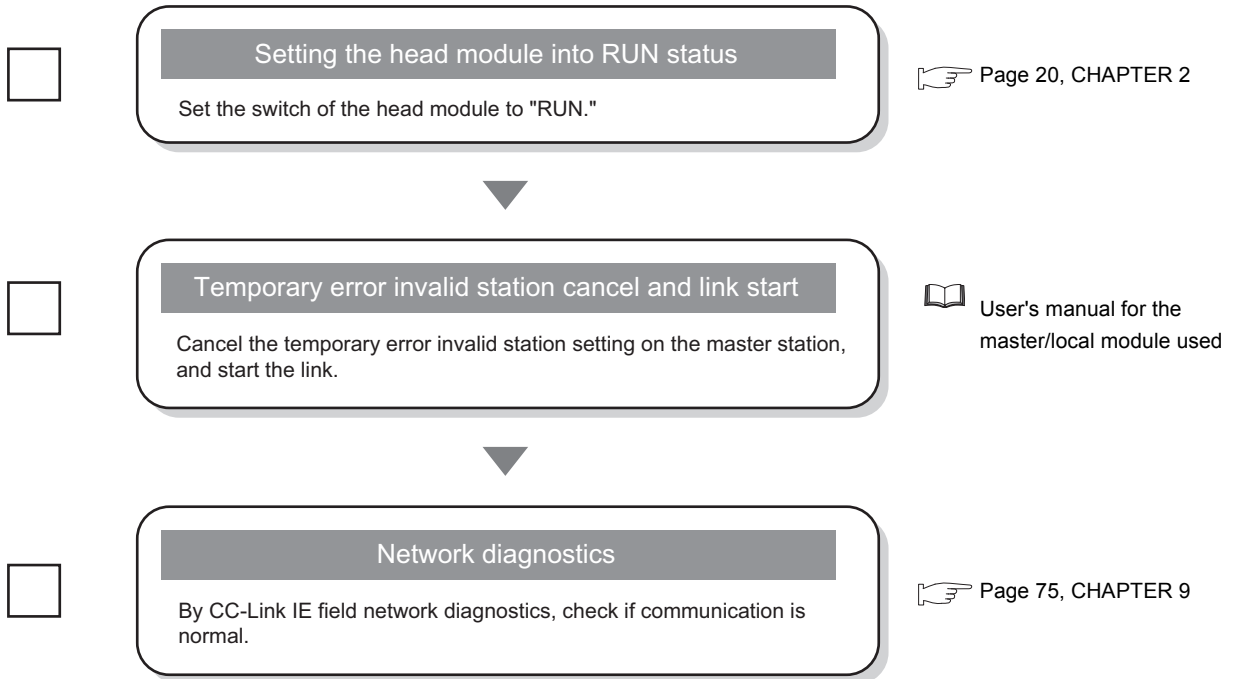



## (2) Precautions

### (a) Setting a station number from the CC-Link IE Field Network diagnostics of the master station

- The network number will be the same as that of the master station.
- The network number and the station number can be checked in Station No. set for diagnostics (SW004E and SW004F).
- When a network number and a station number are set in the "Communication Head Setting" tab of PLC parameter, the parameter settings take priority.
- When the module operates with the station number set in the "Communication Head Setting" tab of PLC parameter, Operating station number status (SB004F) turns off.
- When the module operates with the station number set from the CC-Link IE Field Network diagnostics, Operating station number status (SB004F) turns on.

### (b) Changing a station number from the CC-Link IE Field Network diagnostics of the master station

Use the following module and GX Works2.

- Master/local module with a serial number (first five digits) of "13032" or later
- GX Works2 with Version 1.53F or later

If using a master/local module or GX Works2 not meeting the above condition, perform the following operation using GX Works2 connected to the head module, clear the station number, and set a station number of the head module again.

1. Leave the "Network No." and "Station No." fields blank in the "Communication Head Setting" tab of PLC parameter. (👉 Page 53, Section 7.1 (1))
2. Execute the format PLC memory function on the head module using GX Works2.
3. Write PLC parameters to the head module.
4. Reset the head module or power off and on the system.

**(3) Module replacement example**

1. Execute the read from PLC function and load parameters written in the head module to a project of GX Works2.
2. Connect GX Works2 to the master station, and stop the data link from the CC-Link IE Field Network diagnostics.
3. From the CC-Link IE Field Network diagnostics, set the head module as a temporary error invalid station.
4. Replace the head module.

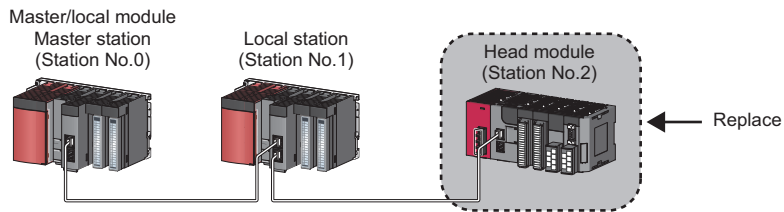

5. If the new head module does not have a station number, connect GX Works2 to the master station, and assign a station number to the head module from the CC-Link IE Field Network diagnostics.

[Diagnostics] ⇒ [CC-Link IE Field Diagnostics] ⇒ Select the head module with station number not set in "Network Status". ⇒ Click the  button.

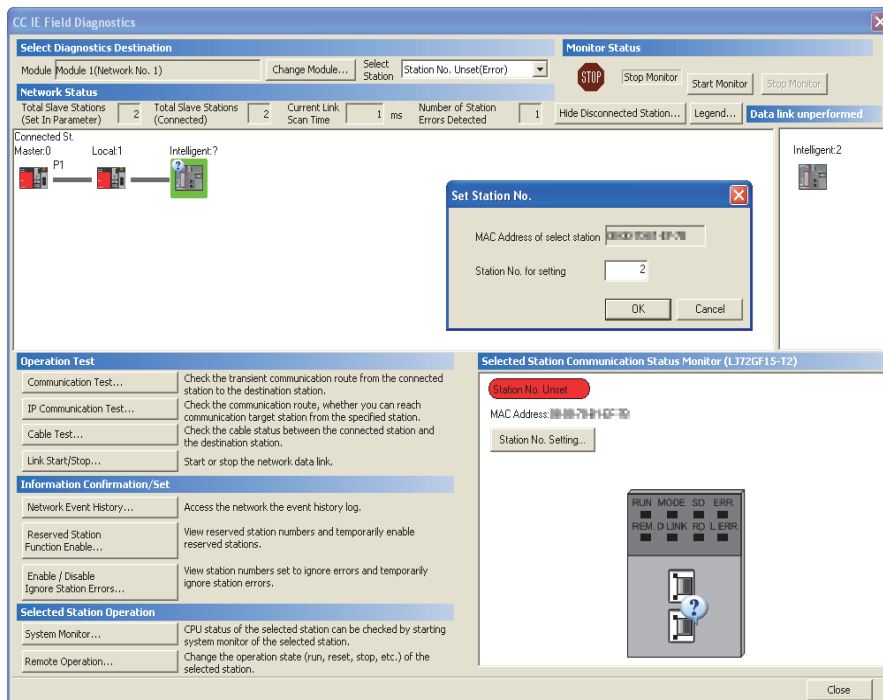

6. Write the parameters read in step 1 to the new head module.  
The written parameters are reflected when the system is powered off and on, or when the head module is reset.
7. Move the switch on the head module to the "RUN" position.
8. Clear the temporary error invalid station setting configured in step 3.

# CHAPTER 5 SYSTEM CONFIGURATION

---

This chapter describes system configuration using a head module.  
For CC-Link IE Field Network configuration, refer to the following.

 User's manual for the master/local module used

## 5.1 Head Module System Configuration

---

The following figure shows a system configuration using a head module.

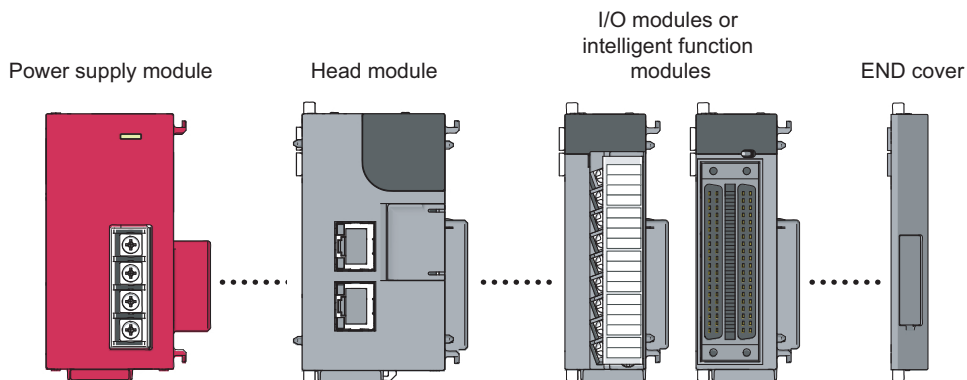

For power supply modules, refer to the following.

 MELSEC-L CPU Module User's Manual (Hardware Design, Maintenance and Inspection)

For I/O modules and intelligent function modules, refer to the manual for the module used.



The MELSEC-L series CPU module cannot be connected to a system using a head module.

---

## 5.2 Applicable System

### (1) Connectable modules and the number of modules

#### (a) Connectable modules

MELSEC-L series modules can be connected to the head module.

Note that there are some modules with restrictions or that can be connected but cannot be used.

#### (b) Number of modules

Up to 10 I/O modules and intelligent function modules can be connected in total.\*1\*2

\*1 The power supply module and END cover are not included.

\*2 Some intelligent function modules occupy two module spaces. Refer to the user's manual for the module used, and check the the number of spaces to be occupied before configuring a system.

Some modules have restrictions on the number of modules to be connected. The following table provides the relevant models and the number of connectable modules.

Module	Model	Number of modules
Head module	LJ72GF15-T2	1
CC-Link system master/local module	LJ61BT11	Up to 4

### (2) Modules/unit that cannot be connected

The CPU module and the following modules/unit cannot be connected to the head module.

Module/unit	Model
Branch module	L6EXB
Extension module	L6EXE
RS-232 adapter	L6ADP-R2
Display unit	L6DSPU
CC-Link IE Field Network master/local module	LJ71GF11-T2
SSCNET III/H head module	LJ72MS15
Ethernet interface module	LJ71E71-100

- The positioning module and simple motion module cannot be connected to the head module with a serial number (first five digits) of "12071" or earlier.

### (3) Software package

GX Works2 is required for setting and diagnosing the head module.

GX Developer cannot be used.

Software	Version
GX Works2	Version 1.31H or later

### (4) Precautions for system configuration

#### (a) Rated output current (5VDC)

Configure a system so that the total current consumption may not exceed 5VDC, the rated output current of the power supply module. For specifications of the power supply module, refer to the following.

 MELSEC-L CPU Module User's Manual (Hardware Design, Maintenance and Inspection)

# CHAPTER 6 INSTALLATION AND WIRING

This chapter describes how to install and wire modules.

## 6.1 Wiring Environment and Installation Position

When installing modules in a control panel, fully consider its operability, maintainability, and environmental resistance.

### 6.1.1 Installation environment

Install the programmable controller according to the installation environment shown in the general specifications.

(☞ Page 24, Section 3.1)

Do not install the programmable controller to the place where:

- Ambient temperature is outside the range of 0 to 55°C;
- Ambient humidity is outside the range of 5 to 95%RH;
- Condensation occurs because of rapid temperature change;
- Corrosive gas or combustible gas is present;
- Conductive powder such as dust and iron powder, oil mist, salinity, or organic solvent is filled;
- The programmable controller is exposed to direct sunlight;
- A strong electric field or strong magnetic field is generated; and
- The programmable controller is subject to vibration and shock.

### 6.1.2 Installation position

To ensure good ventilation and ease module change, provide clearance between the module top/bottom and structures/parts as shown below.

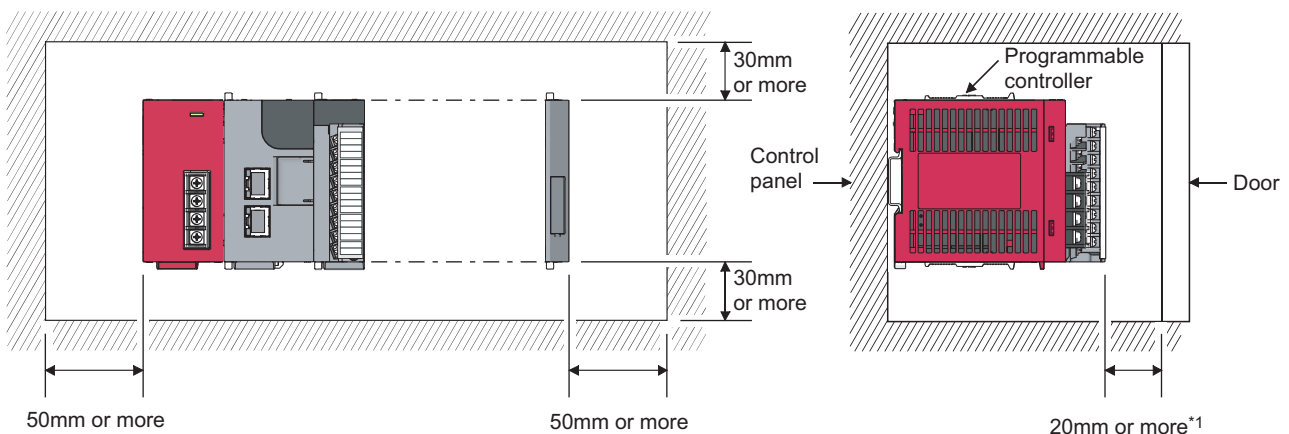

\*1 When using connectors for external devices, provide clearance of 80mm or more.

## 6.2 Installation

This section describes how to interconnect modules and how to mount them on a DIN rail.

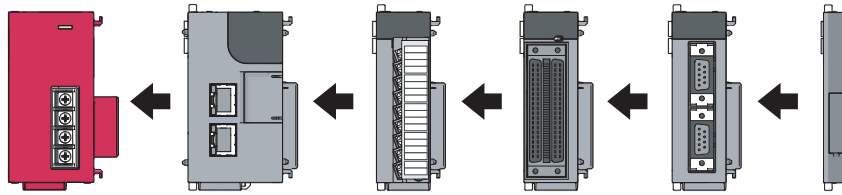

### Point

- Modules must be mounted on a DIN rail.
- Connect an END cover on the right of the terminal module.

### (1) Precautions for connecting and mounting modules

- Do not directly touch any conductive parts and electronic components of the module. Doing so can cause malfunction or failure of the module.
- After the first use of the module, the number of connections/disconnections is limited to 50 times (in accordance with IEC 61131-2). Exceeding the limit may cause malfunction.
- Do not drop or apply strong shock to the module.
- Do not remove the printed-circuit board of the module from the module case. Doing so may cause failure of the module and/or printed-circuit board.

## 6.2.1 Connecting modules

This section describes a procedure for connecting modules with an example of how to connect a head module to the L61P.

Shut off the external power supply (all phases) used in the system before connecting or disconnecting modules.

### (1) Connecting procedure

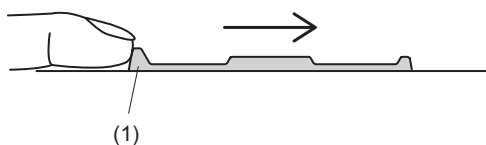
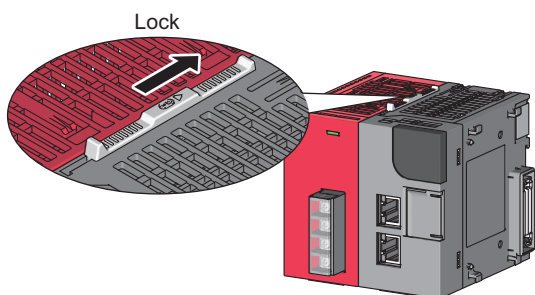
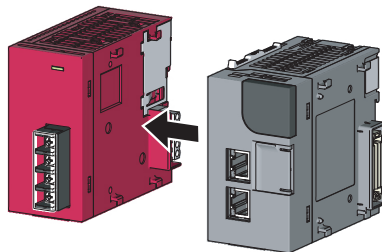
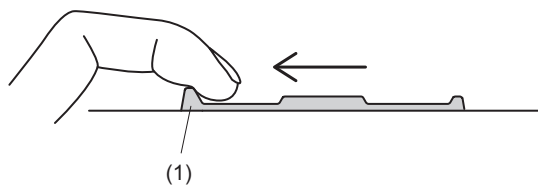
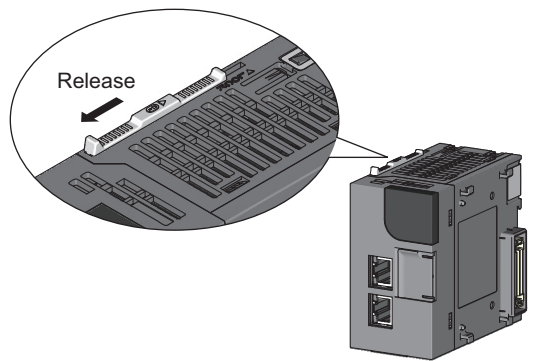

- 1. Release the module joint levers located at the top and bottom of the head module.**
- 2. Slide the lever toward the front side of the module until it clicks. To release the lever, pull the projection (1) of the lever.**
- 3. Insert the connector of the power supply module into that of the head module so that they are securely engaged.**
- 4. Lock the module joint levers.**
- 5. Slide the lever toward the back side of the module until it clicks. Check that the modules are securely connected. To lock the lever, push the projection (1) of the lever.**



## (2) Disconnecting procedure

Reverse the connecting procedure to disconnect the modules.

### Point

- Failure to securely lock the module joint levers until they click may cause malfunction, failure, or drop of the module.
- To slide the lever, use the projection of the lever. Sliding the lever with a part other than the projection may cause a difficulty of sliding.

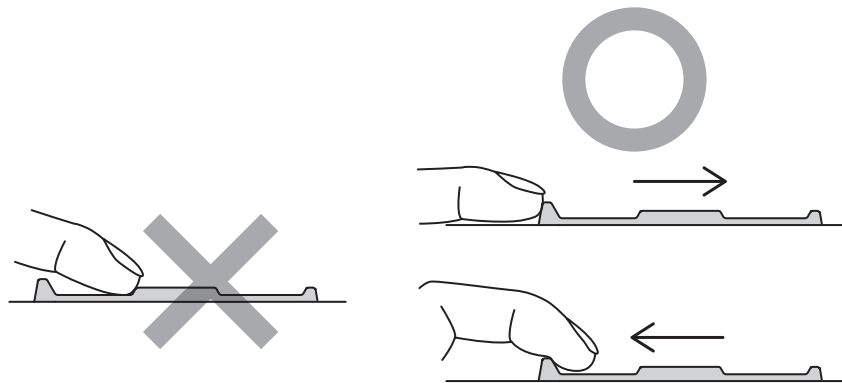

- The temperature of the metal part of a module (back side) may be high immediately after power-off. Be careful not to burn yourself when disconnecting a module.

## 6.2.2 Mounting the modules on a DIN rail

This section describes a procedure for mounting the modules on a DIN rail.

### *Point*

The method for fixing the DIN rail stopper is an example. Fix the module in accordance with the manual for the DIN rail stopper used.

### (1) Mounting procedure

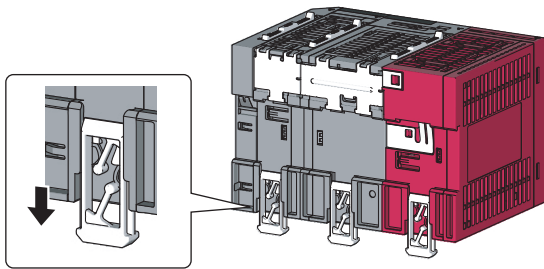

- 1. Pull down all DIN rail hooks on the back of the modules.**  
Pull the hooks down until they click.

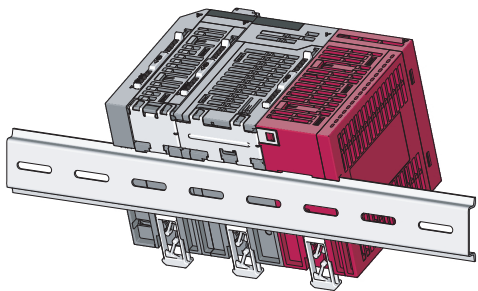

- 2. Hang the upper tabs of the modules on a DIN rail, and push the modules in position.**

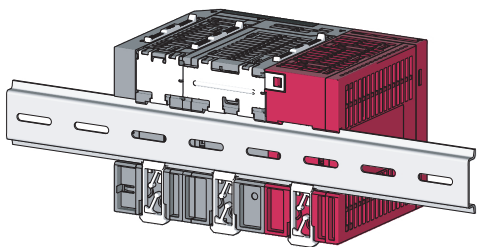

- 3. Lock the DIN rail hooks to the DIN rail to secure the modules in position.**  
Pull the hooks up until they click.  
If the hooks are beyond the reach, use a tool such as a driver.

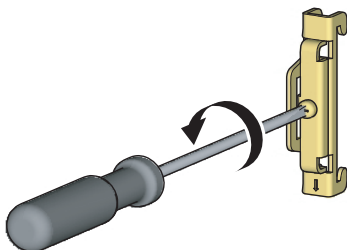

- 4. Loosen the screw of the DIN rail stopper.**

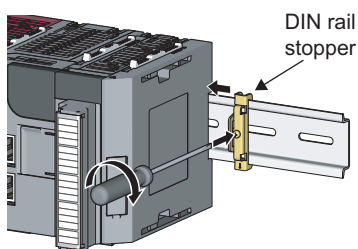
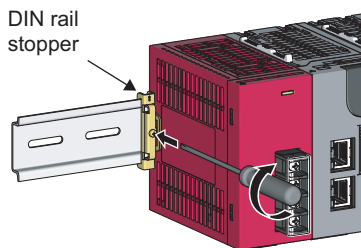
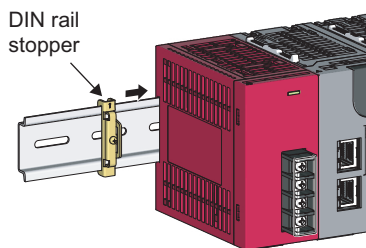
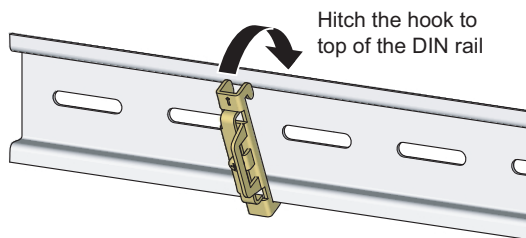
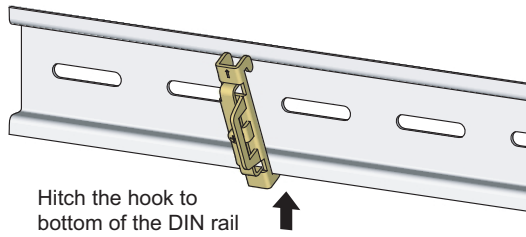

5. Hitch the bottom hook of the DIN rail stopper to the bottom of the DIN rail.

Hitch the hook according to the orientation of the arrow on the front of the stopper.

6. Hitch the upper hook of the DIN rail stopper to the top of the DIN rail.

7. Slide the DIN rail stopper up to the left side of the modules.

8. Hold down the DIN rail stopper in the opposite direction of the arrow marked on the stopper, and tighten the screw on the stopper with a driver.

9. Attach a DIN rail stopper on the right of the modules with the same procedure. Note that a DIN rail stopper is attached upside down on the right side.

Do not slide modules from the edge of the DIN rail when mounting them. Doing so may damage the metal part located on the back of the module.

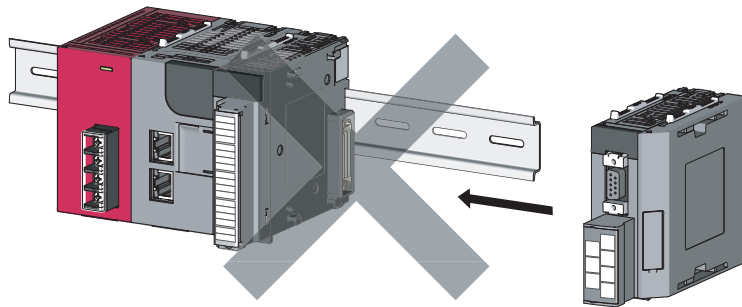

## (2) Removal procedure

Reverse the mounting procedure to remove the modules from the DIN rail.

## (3) Applicable DIN rail models (IEC 60715)

- TH35-7.5Fe
- TH35-7.5Al
- TH35-15Fe

## (4) DIN rail stopper

Use a stopper that is attachable to the DIN rail.

## (5) Interval between DIN rail mounting screws

To ensure the strength of a DIN rail, tighten DIN rail mounting screws (obtained by user) within 30mm away from the both edges of the DIN rail and at 200mm-interval between the screws.

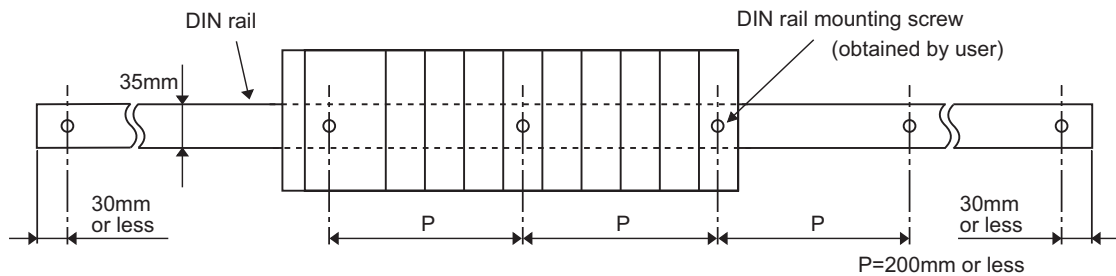

## 6.2.3 Changing modules on a DIN rail

This section describes a procedure for changing modules on a DIN rail by sliding them rightward. Remove the mounted terminal block and disconnect the connectors beforehand.

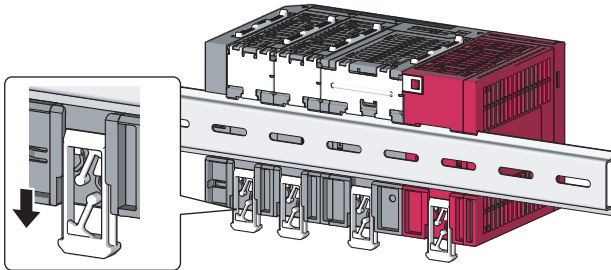

1. Remove the DIN rail stopper on the right side.
2. Pull down all DIN rail hooks on the back of the modules.

Pull down the DIN rail hooks on the module to be changed and the module on its right, until they click. If the hooks are beyond the reach, use a tool such as a driver.

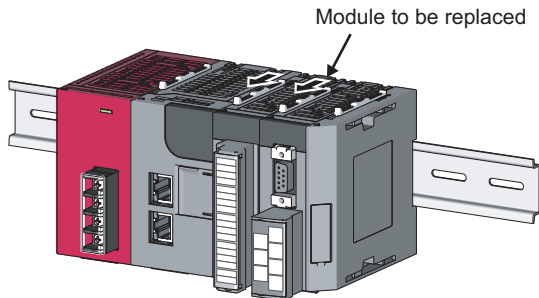

3. Release the module joint levers on the modules. Slide the module joint levers on the module to be changed and the module on its right toward the front side of the module until they click.

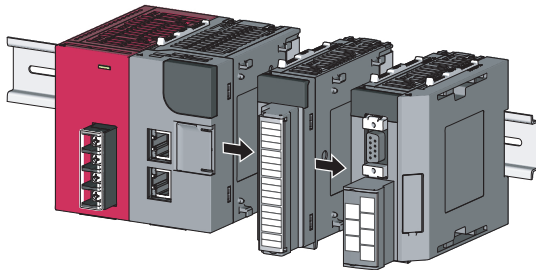

4. Disconnect the module by sliding it.

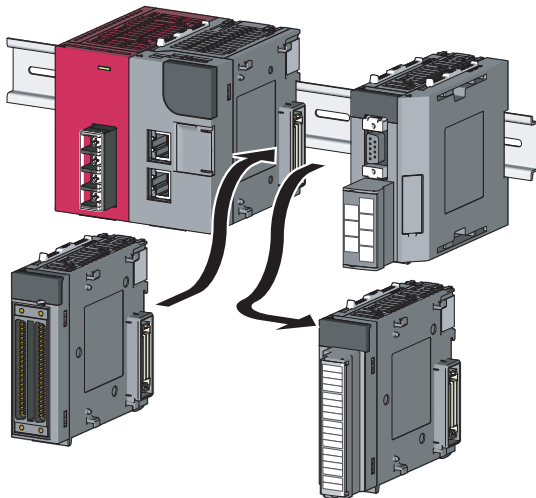

5. Change the module.

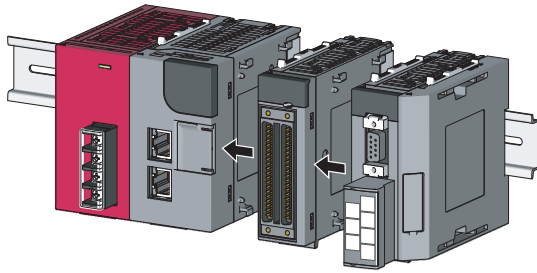

**6. Slide the modules and plug the connectors.**

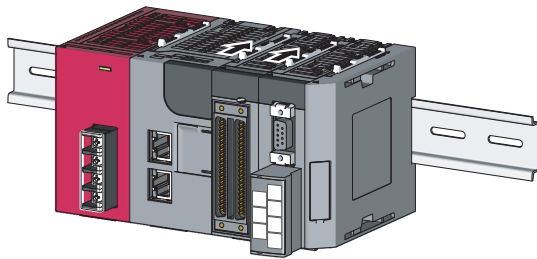

**7. Lock the module joint levers.**

Slide the levers toward the back side of the module until they click.

**8. Lock the DIN rail hooks and attach the DIN rail stopper.**

( Page 40, Section 6.2.2)

**Point** 

Do not slide modules from the edge of the DIN rail when mounting them. Doing so may damage the metal part located on the back of the module.

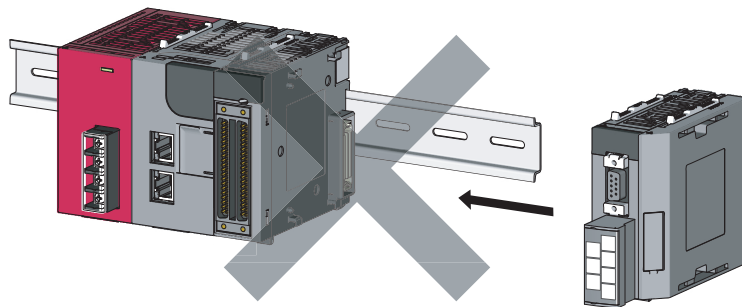

## 6.3 Wiring to the Power Supply Module

For wiring to the power supply module, refer to the following.

 MELSEC-L CPU Module User's Manual (Hardware Design, Maintenance and Inspection)

## 6.4 Testing the Head Module Before Wiring

### (1) Unit test

Perform a unit test to check the hardware status of the head module.

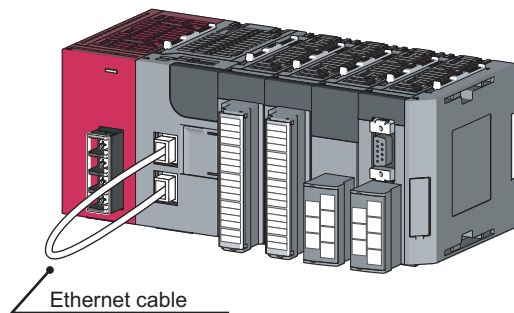

Repeat at intervals of less than 1s.

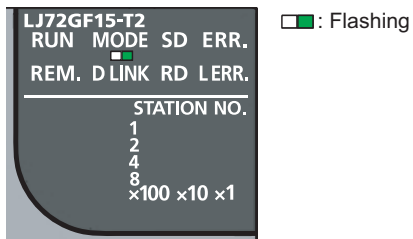
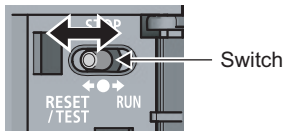

1 second or more

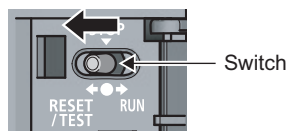

1. Power off the head module.
2. Connect the PORT1 and PORT2 of the head module with an Ethernet cable.
3. Power on the head module.
4. Using the switch on the head module, repeat three cycles of STOP→RESET/TEST→STOP, taking less than one second per cycle. (The MODE LED flashes after the 3rd cycle.)
5. Hold the switch on the front of the head module in the RESET/TEST position for one second or more.

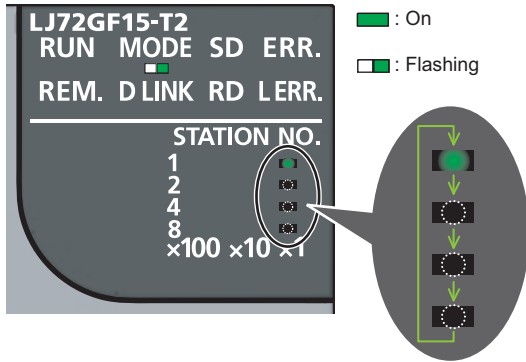

## 6. Unit test starts.

The MODE LED starts flashing, and the ×1 or ×10 LED starts turning on and off repeatedly in the sequence of 1→2→4→8→1.

When completed

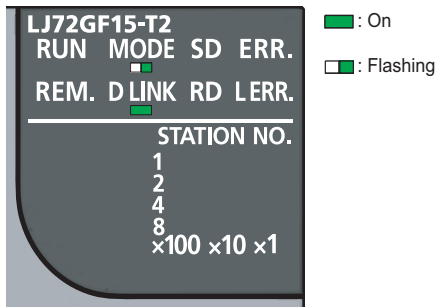

## 7. The ×1 or ×10 LED stops turning on and off, and the D LINK LED turns on when the test is completed.

- When completed successfully  
The D LINK LED turns on, and the ERR. LED remains off.
- When failed  
The following LEDs turn on.
  - Either the ×1 or ×10 LED
  - ERR. LED
  - D LINK LED

If the test fails, replace the Ethernet cable, and perform the test again. If the test fails again, the possible cause is a hardware failure of the head module.

Please consult your local Mitsubishi representative.

When failed

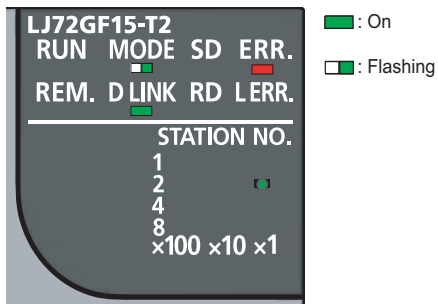



## 6.5 Wiring to the Head Module

This section describes the wiring to the head module.

### 6.5.1 Wiring

This section describes how to connect an Ethernet cable to the head module and wiring precautions. For network configuration and cables/hubs required for wiring, refer to the following.

 User's manual for the master/local module used

#### (1) Connecting an Ethernet cable

##### (a) Connecting procedure

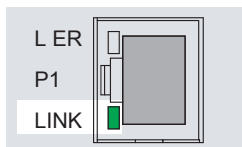
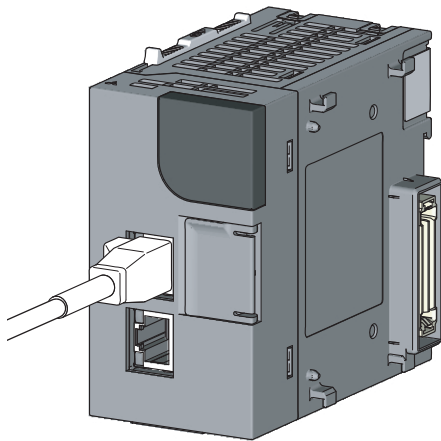

1. Power off both the head module and the device to be connected.
2. Push the Ethernet cable connector into the head module until it clicks. Pay attention to the connector's direction.

3. Power on the head module.
4. Power on the external device connected to PORT1 or PORT2 of the head module.
5. Check that the LINK LED of the port where the Ethernet cable is connected is on.

The time between the power-on and the LINK LED turning on may vary. The LINK LED usually turns on in a few seconds. Note, however, that the time may be extended further depending on the status of the device on the line if the link-up processing is repeated. If the LINK LED does not turn on, refer to the following and take actions. ( Page 91, Section 11.4)

It is not necessary to distinguish between PORT1 and PORT2.

- When only one connector is used in star topology, an Ethernet cable can be connected to either PORT1 or PORT2.

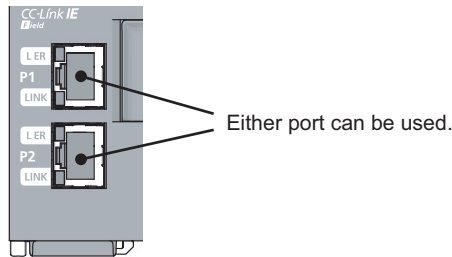

- When two connectors are used in line topology or ring topology, an Ethernet cable can be connected to the connectors in any combination. For example, the cable can be connected between PORT1s and between PORT1 and PORT2.

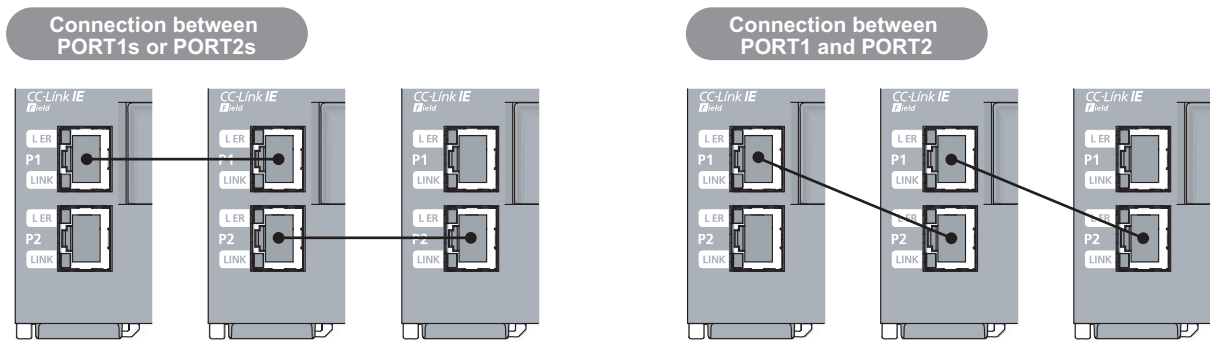

**(b) Disconnecting procedure**

- 1. Power off both the head module and the device being connected.**
- 2. Press the latch down and unplug the Ethernet cable.**

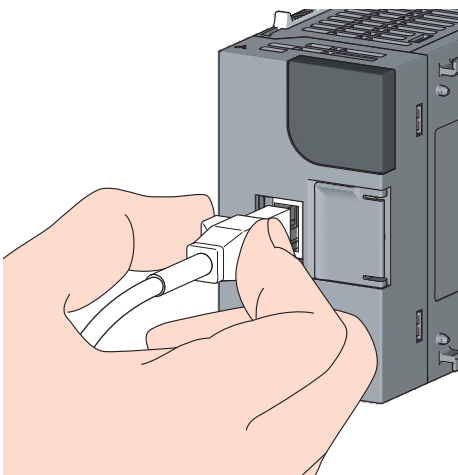

## 6.5.2 Grounding

Observe the following:

- Provide independent grounding when possible. Ground the FG and LG terminals of the programmable controller with a ground resistance of  $100\Omega$  or less.
- If independent grounding cannot be provided, employ shared grounding (figure (2) below).

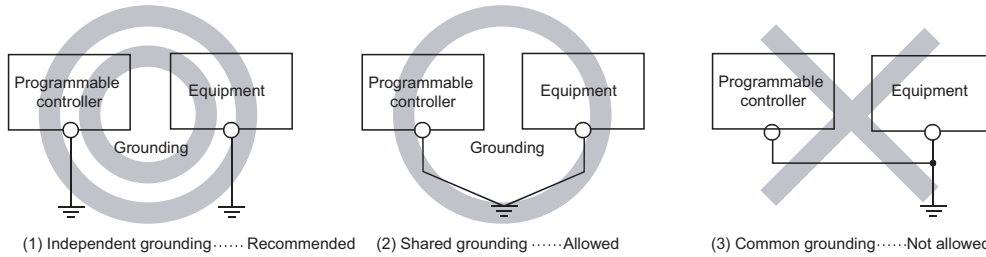

- Use the thickest cable (maximum of  $2\text{mm}^2$ ). Bring the grounding point close to the programmable controller as much as possible so that the ground cable can be shortened.

## 6.5.3 Precautions

---

This section describes wiring precautions.

### (1) Laying Ethernet cables

- Place the Ethernet cable in a duct or clamp them. If not, dangling cable may swing or inadvertently be pulled, resulting in damage to the module or cables or malfunction due to poor contact.
- Do not touch the core of the cable-side or module-side connector, and protect it from dirt or dust. If any oil from your hand, or any dirt or dust sticks to the core, it can increase transmission loss, causing data link to fail.
- Check the following:
  - Are the Ethernet cables connected properly?
  - Isn't any Ethernet cable short-circuited?
  - Are the connectors securely connected?

### (2) Broken cable latch

Do not use Ethernet cables with broken latches. Doing so may cause the cable to unplug or malfunction.

### (3) Connecting and disconnecting Ethernet cables

Hold the connector part when connecting and disconnecting an Ethernet cable. Pulling the cable connected to the module may result in malfunction or damage to the module or cable.

### (4) Connectors where an Ethernet cable is not connected

To prevent dust from entering the module, attach the provided connector cover.

### (5) Maximum station-to-station distance (Maximum Ethernet cable length)

The maximum station-to-station distance of an Ethernet cable is 100m. However, the distance may be shorter depending on the operating environment of the cable. For details, contact the manufacturer of the cables used.

### (6) Bending radius of the Ethernet cable

There are restrictions on the bending radius of the Ethernet cable. For details, check the specifications of the Ethernet cable used.

# CHAPTER 7 PARAMETER SETTINGS

This chapter describes parameter settings of the head module and modules connected to the head module. Open the setting windows by the following operation.

 Project window ⇨ [Parameter] ⇨ [PLC Parameter]

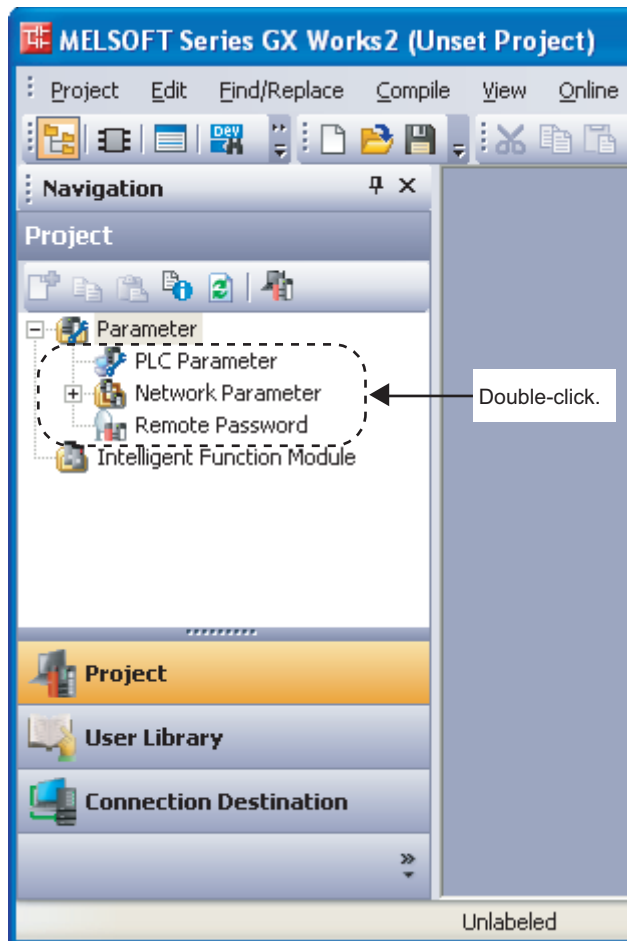

## Point

- Set parameters for the entire network (such as the number of slave stations, link device assignment, reserved station specification, and temporary error invalid station setting) to the master station. For details, refer to the following.
  -  User's manual for the master/local module used
- Routing parameters, used for communications with other networks, do not need to be set to the head module. Communications with other networks are performed according to the routing parameters set to the master station.

# 7.1 PLC Parameters

This section describes details on PLC parameters together with their setting windows.

Window	Description	Parameter No. *1	Reference
Communication Head Setting	Set parameters for connecting the head module to CC-Link IE Field Network.	01F0H	Page 53, Section 7.1 (1)
PLC Name	Set the label and comment of the head module.	0000H, 0001H	Page 54, Section 7.1 (2)
PLC System	Set parameters for the system including the head module.	1002H	Page 55, Section 7.1 (3)
PLC RAS	Set parameters for the RAS function.	300AH	Page 56, Section 7.1 (4)
Operation Setting	Set parameters to transfer data stored in the following head module devices as cyclic data. <ul style="list-style-type: none"> <li>• Link special relay (SB)</li> <li>• Link special register (SW)</li> <li>• Special relay (SM)</li> <li>• Special register (SD)</li> <li>• Link register (W)</li> </ul>	500FH	Page 57, Section 7.1 (5)
I/O Assignment	Set connection status of each module.	0400H, 0403H to 0405H, 0409H	Page 61, Section 7.1 (6)

\*1 Parameter numbers are used to identify a location where a parameter error has occurred.

### (1) Communication Head Setting

Set parameters for connecting the head module to CC-Link IE Field Network.

 Project window ⇨ [Parameter] ⇨ [PLC Parameter] ⇨ "Communication Head Setting"

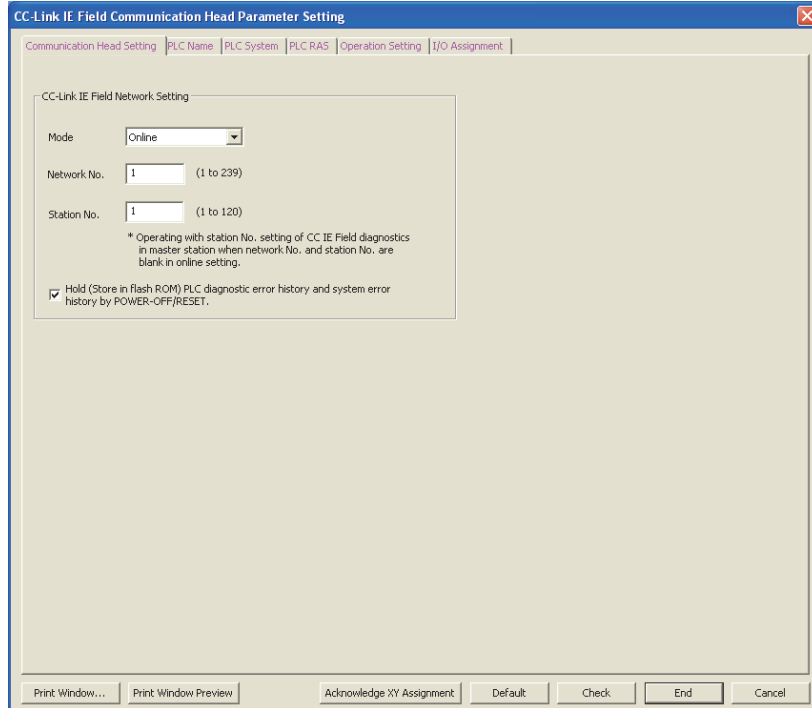

The following table lists parameter items.

Item	Description	Setting range
Mode	Select the mode of the head module.	Online/Offline (Default: Online)
Network No.	Set the network number of the head module.	• Blank*1 • 1 to 239 • (Default: Blank)
Station No.	Enter the station number of the head module.	• Blank*1 • 1 to 120 • (Default: Blank)
Hold (Store in flash ROM) PLC diagnostic error history and system error history by POWER-OFF/RESET.	Select whether to hold PLC diagnostic results and system error history data after the head module is powered off or is reset. Clearing the checkbox will delete data displayed in the "PLC diagnostics" window and the "Error History" window when the head module is powered off or is reset.  Page 86, Section 11.2 (1) (a), Page 89, Section 11.3	Selected/Not selected (Default: Selected)

\*1 When the "Network No." and "Station No." fields are left blank in online mode, the head module will operate with the station number set in CC-Link IE Field Network diagnostics for the master station. For details, refer to "Procedure for Changing the Head Module".  Page 31, Section 4.2

## (2) PLC Name

Set the label and comment of the head module.

 Project window ⇨ [Parameter] ⇨ [PLC Parameter] ⇨ "PLC Name"

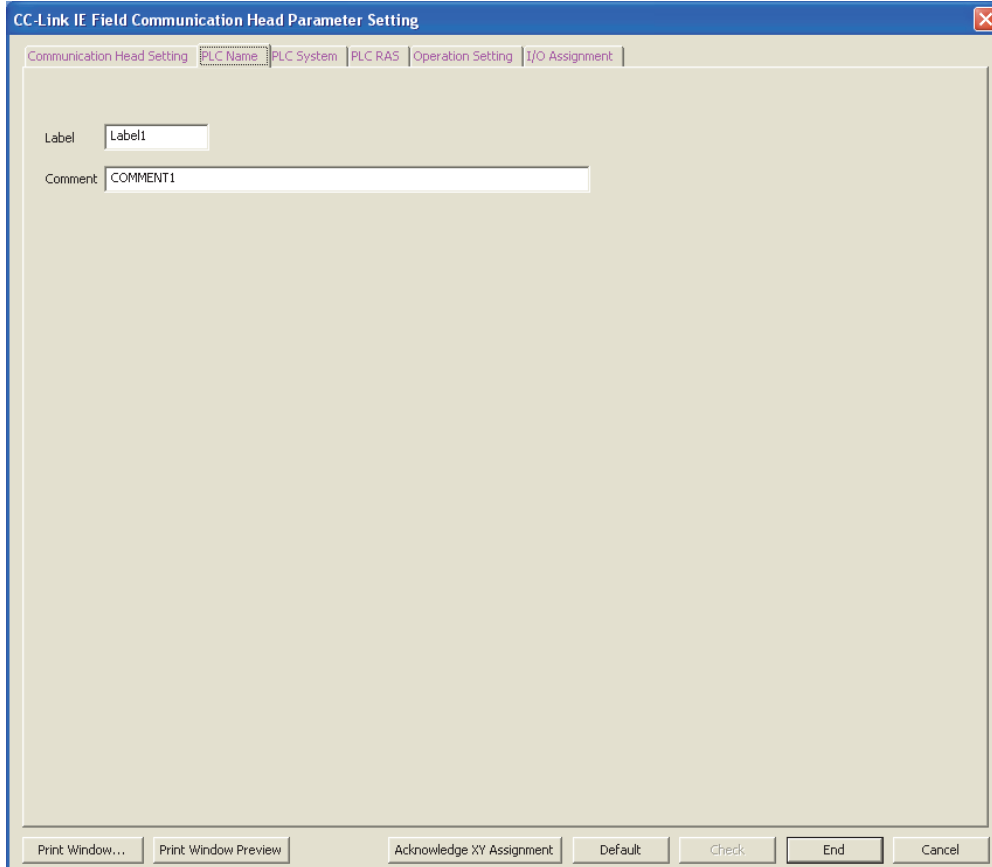

CC-Link IE Field Communication Head Parameter Setting

Communication Head Setting | **PLC Name** | PLC System | PLC RAS | Operation Setting | I/O Assignment

Label: Label1

Comment: COMMENT1

Print Window... | Print Window Preview | Acknowledge XY Assignment | Default | Check | End | Cancel

The following table lists parameter items.

Item	Description	Setting range
Label	Enter the label (name or application) of the head module.	Up to 10 one-byte characters (Default: Blank)
Comment	Enter the comment of the head module.	Up to 64 one-byte characters (Default: Blank)



### (3) PLC System

Set parameters for the system including the head module.

 Project window ⇨ [Parameter] ⇨ [PLC Parameter] ⇨ "PLC System"

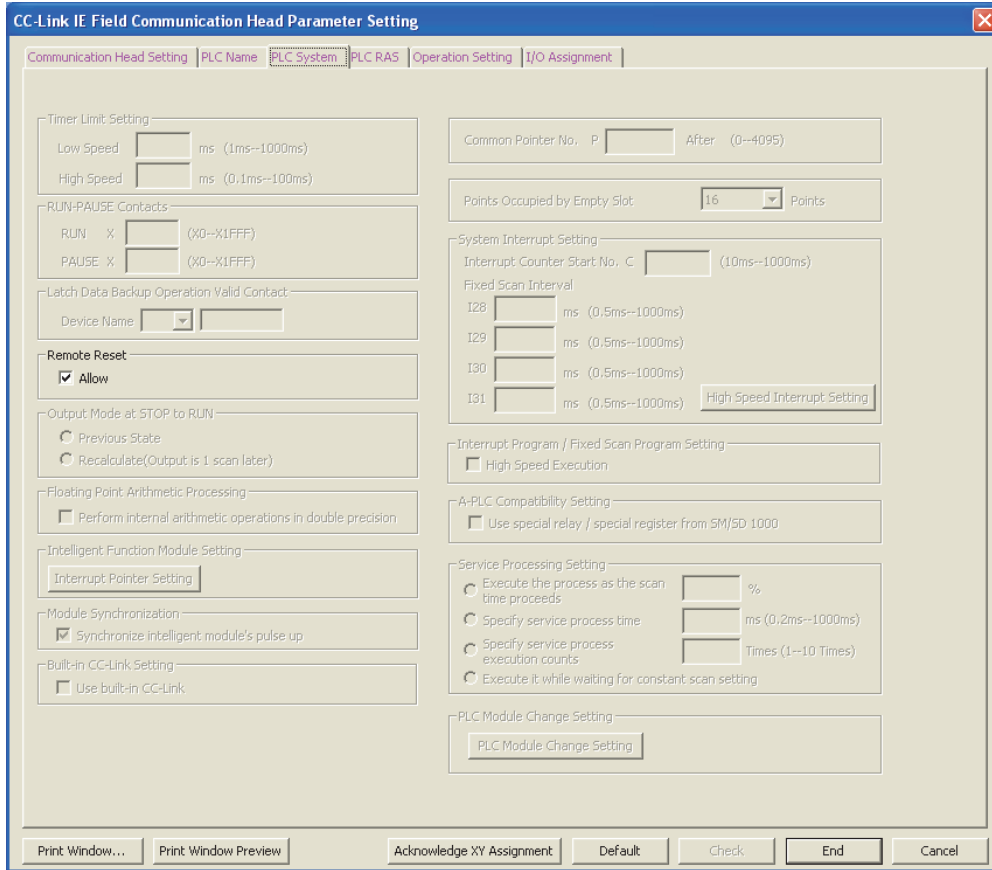

The following table lists parameter items.

Parameters other than "Remote Reset" do not need to be set to the head module.

Item	Description	Setting range
Remote Reset	Allow	Select whether to allow GX Works2 to perform remote reset to the head module. Selected/Not selected (Default: Selected*1)

\*1 The default differs from that of the CPU module. Note that when remote reset is performed to all stations.

#### (4) PLC RAS

Set parameters for the RAS function.

 Project window ⇨ [Parameter] ⇨ [PLC Parameter] ⇨ "PLC RAS"

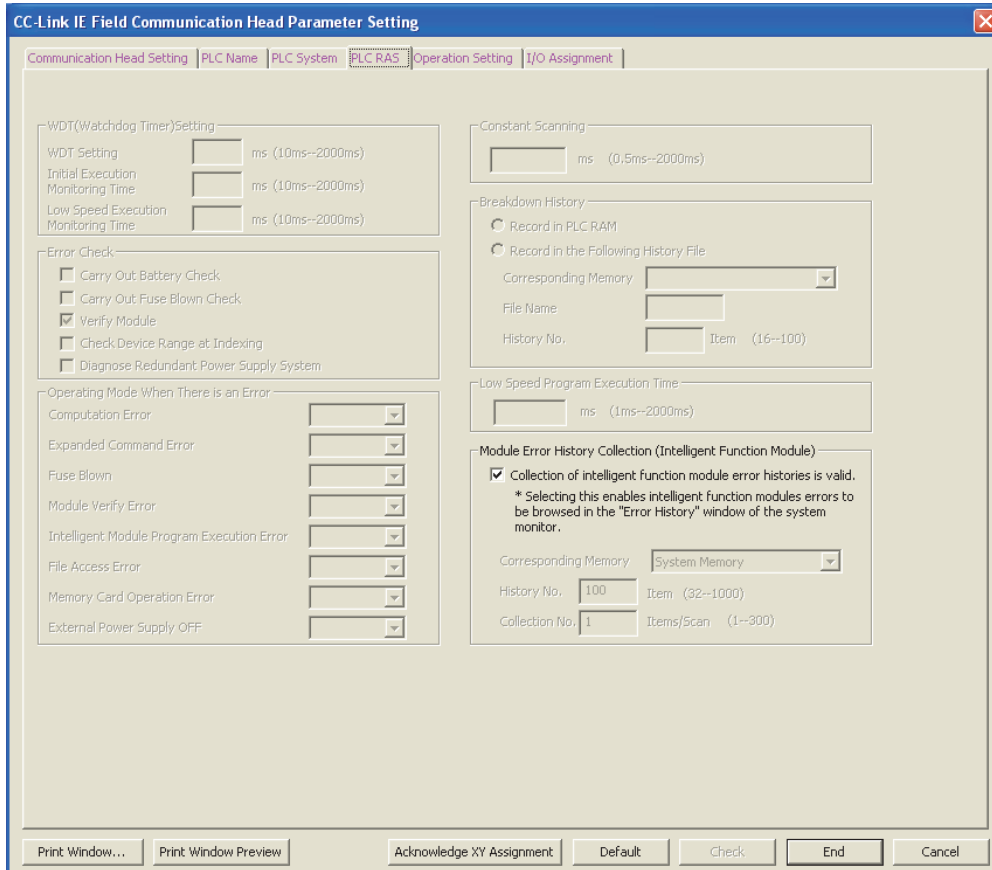

The following table lists parameter items.

Parameters other than "Module Error History Collection (Intelligent Function Module)" do not need to be set to the head module.

Item		Description	Setting range
Module Error History Collection (Intelligent Function Module)	Collection of intelligent function module error histories is valid.	Select whether to collect errors occurred in an intelligent function module with the head module.	Selected/Not selected (Default: Selected)

**(5) Operation Setting**

Set parameters to transfer data stored in the following head module devices as cyclic data.

- Link special relay (SB)
- Link special register (SW)
- Special relay (SM)
- Special register (SD)
- Link register (W)

In Operation Setting, the following  $\longleftrightarrow$  part is configured.

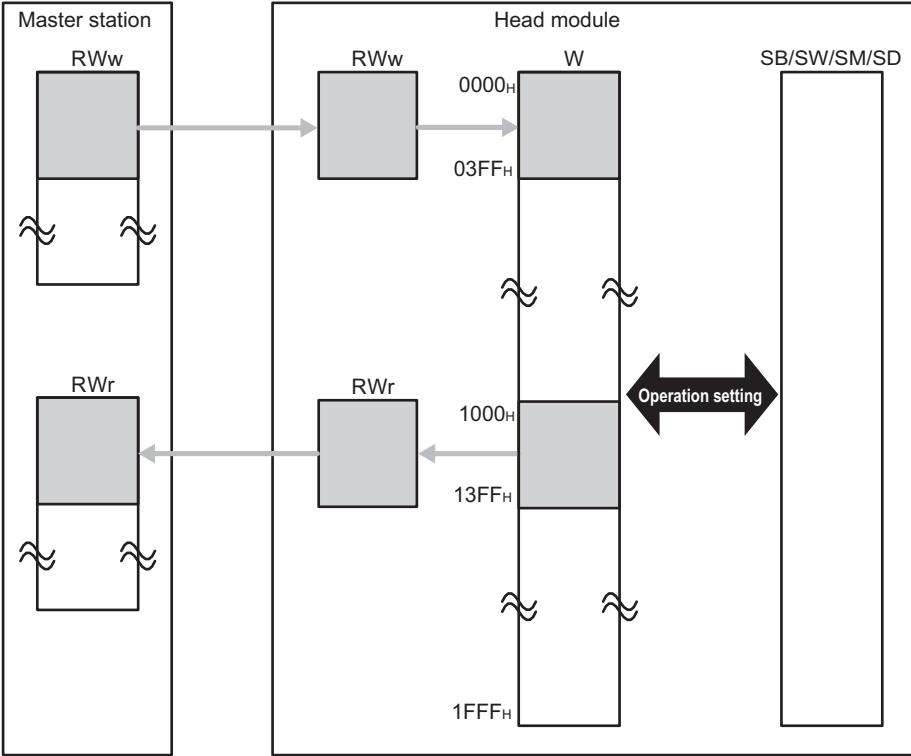

Project window ⇨ [Parameter] ⇨ [PLC Parameter] ⇨ "Operation Setting"

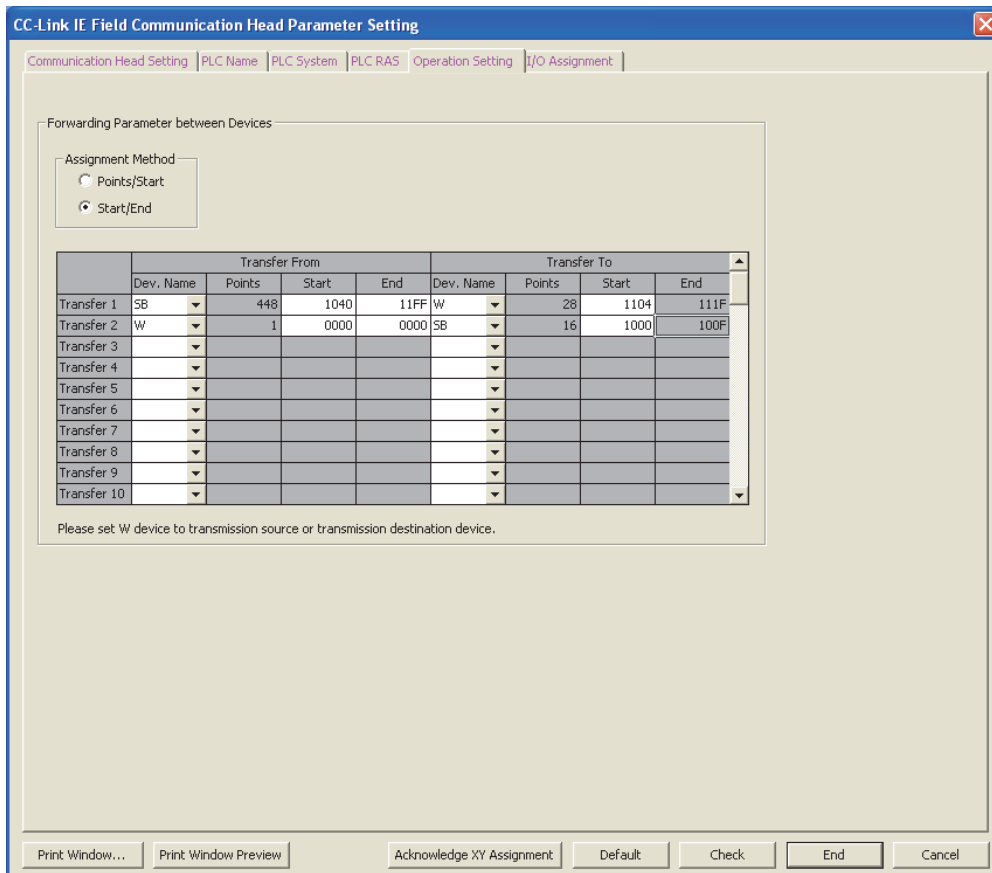

The following table lists parameter items.

Item	Description	Setting range
Assignment Method	Select a link device assignment method. <ul style="list-style-type: none"> <li>Points/Start: Enter the points and start numbers of link devices.</li> <li>Start/End: Enter the start and end numbers of link devices.</li> </ul>	<ul style="list-style-type: none"> <li>Points/Start</li> <li>Start/End</li> </ul> (Default: Start/End)
Dev. Name	Set a transfer source device and transfer target device. Set "W" for either of the devices.	<ul style="list-style-type: none"> <li>W</li> <li>SB</li> <li>SW</li> <li>SM</li> <li>SD</li> </ul> (Default: Blank)
Points	Enter the number of points of the device to be transferred.	<ul style="list-style-type: none"> <li>W: 1 to 4096</li> <li>SB: 16 to 8192</li> <li>SW: 1 to 8192</li> <li>SM: 16 to 2048</li> <li>SD: 1 to 2048</li> </ul> (Default: Blank)

Item	Description	Setting range
Start	Enter the start number of the device to be transferred.	Transfer From • W: 0 to 1FFF • SB: 0 to 1FF0 • SW: 0 to 1FFF • SM: 0 to 2032 • SD: 0 to 2047 (Default: Blank)  Transfer To • W: 1000 to 1FFF • SB: 0 to 1FF0 • SW: 0 to 1FFF • SM: 0 to 2032 • SD: 0 to 2047 (Default: Blank)
End	Enter the end number of the device to be transferred.	Transfer From • W: 0 to 1FFF • SB: F to 1FFF • SW: 0 to 1FFF • SM: 15 to 2047 • SD: 0 to 2047 (Default: Blank)  Transfer To The number is automatically set according to the setting of transfer source.

**(a) Setting example**

To transfer the link special relay (SB) data of the head module as cyclic data, transfer the link special relay (SB) value to the link register (W).

Setting for Forwarding Parameter between Devices

	Transfer From				Transfer To			
	Dev. Name	Points	Start	End	Dev. Name	Points	Start	End
Transfer 1	SB	448	1040	11FF	W	28	1104	111F
Transfer 2	W	1	0000	0000	SB	16	1000	100F

Transfer 1: Transfers the values in SB1040 to SB11FF to W1104 to W111F.

Transfer 2: Transfers the value in W0000 to SB1000 to SB100F.

Operation of the head module

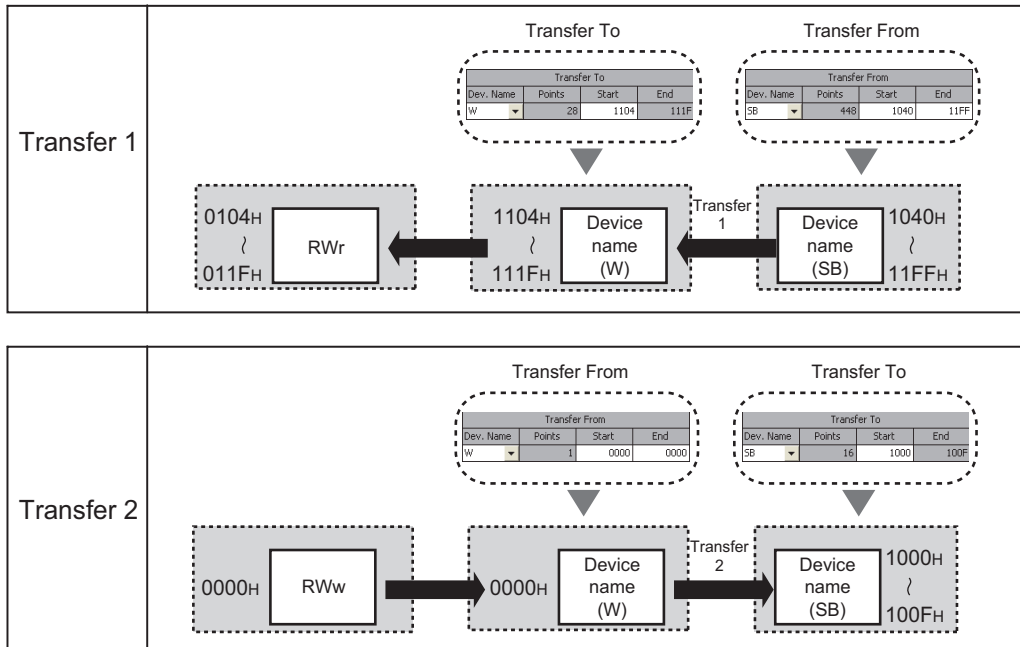



## (6) I/O Assignment

Set connection status of each module.

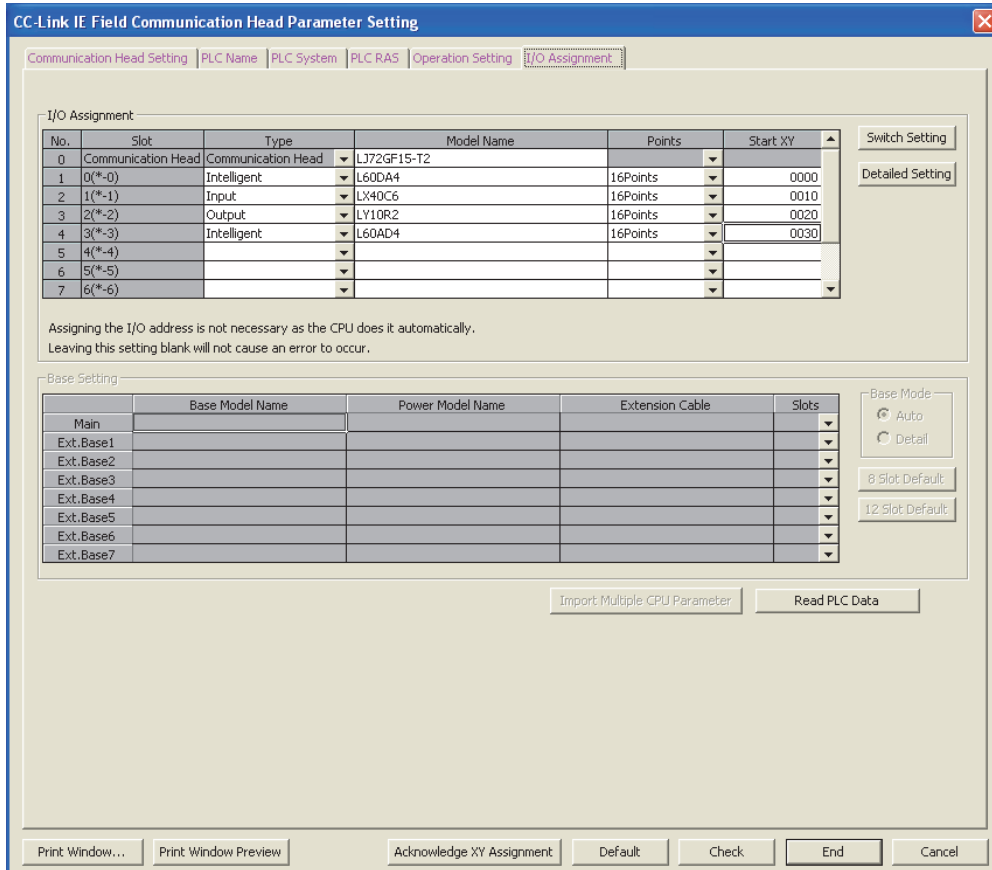
 Project window ⇨ [Parameter] ⇨ [PLC Parameter] ⇨ "I/O Assignment"



The following table lists parameter items.

Item		Description	Setting range
I/O Assignment	Type	Set the type of a connected module.	Empty, Input, Output, Intelligent (Default: Blank)
	Model Name	Enter the model name of the connected module if required.	Up to 16 one-byte characters (Default: Blank)
	Points	Select the number of occupied I/O points of the module connected to the head module.	0 Point, 16 Points, 32 Points, 64 Points, 128 Points (Default: Blank)
	Start XY	Enter the start I/O number.	0000H to 0FF0H (Default: Blank)
 button		Set intelligent function module switches.	—
 button	Error Time Output Mode	Select output mode in the following status: · An error has occurred in the head module. · A data link error has occurred.	Clear/Hold (Default: Clear)
	PLC Operation Mode at H/W Error	Select whether to stop auto refresh of the head module when a hardware failure occurs in an intelligent function module (when the head module detects SP.UNIT DOWN).	Stop/Continue (Default: Stop)
	I/O Response Time	Set the response time of an input module.	1ms, 5ms, 10ms, 20ms, 70ms (Default: 10ms)

## 7.2 Network Parameters

Set parameters of the CC-Link master/local module connected to the head module.

 Project window ⇨ [Parameter] ⇨ [Network Parameter] ⇨ [CC-Link]

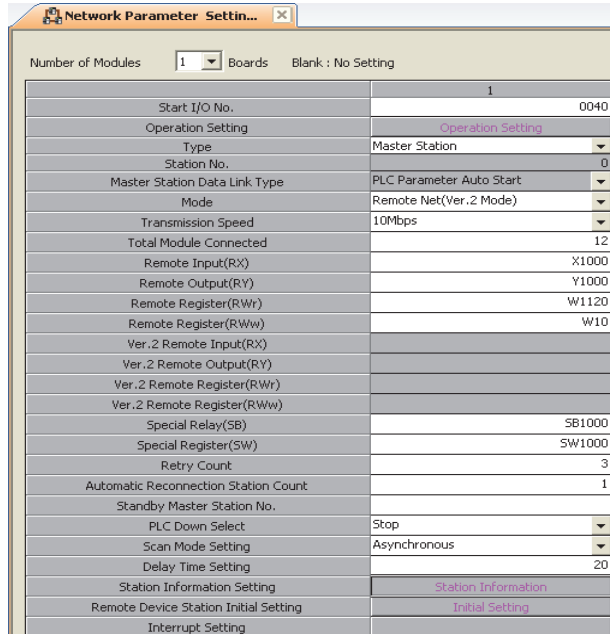

Parameter	Value
Start I/O No.	0040
Operation Setting	Operation Setting
Type	Master Station
Station No.	0
Master Station Data Link Type	PLC Parameter Auto Start
Mode	Remote Net(Ver.2 Mode)
Transmission Speed	10Mbps
Total Module Connected	12
Remote Input(RX)	X1000
Remote Output(RY)	Y1000
Remote Register(RWr)	W1120
Remote Register(RWw)	W10
Ver.2 Remote Input(RX)	
Ver.2 Remote Output(RY)	
Ver.2 Remote Register(RWr)	
Ver.2 Remote Register(RWw)	
Special Relay(SB)	SB1000
Special Register(SW)	SW1000
Retry Count	3
Automatic Reconnection Station Count	1
Standby Master Station No.	
PLC Down Select	Stop
Scan Mode Setting	Asynchronous
Delay Time Setting	20
Station Information Setting	Station Information
Remote Device Station Initial Setting	Initial Setting
Interrupt Setting	

For details, refer to the following.

 MELSEC-L CC-Link System Master/Local Module User's Manual

### Point

Configure a CC-Link system so that the points of devices used for CC-Link communications (RX/RX/RWr/RWw) may be within the maximum link points per station. (👉 Page 26, Section 3.2)

If the CC-Link points exceeds the maximum link points per station in a large-scale system containing 64 stations, for example, use W as a refresh device, instead of X and Y. (👉 Page 71, Section 8.2)



# 7.3 Remote Password

Set a remote password to a serial communication module.

 Project window ⇨ [Parameter] ⇨ [Remote Password]

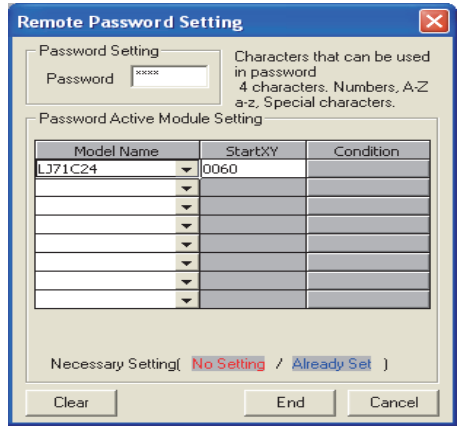

The following table lists parameter items.

Item		Description	Setting range
Password Setting		Enter a remote password.	Up to four one-byte characters (alphanumeric characters, special symbols) (Default: Blank)
Password Active Module Setting	Model Name	Select the model name of the target serial communication module.	LJ71C24 (Default: Blank)
	Start XY	Enter the start I/O number of the target serial communication module.	0000H to 0FE0H

**Point** 

For details on a remote password, refer to the following.



 User's manual for the serial communication module used

# 7.4 Intelligent Function Module Parameters

Set intelligent function module parameters.  
 Set parameters in the "New Module" window.

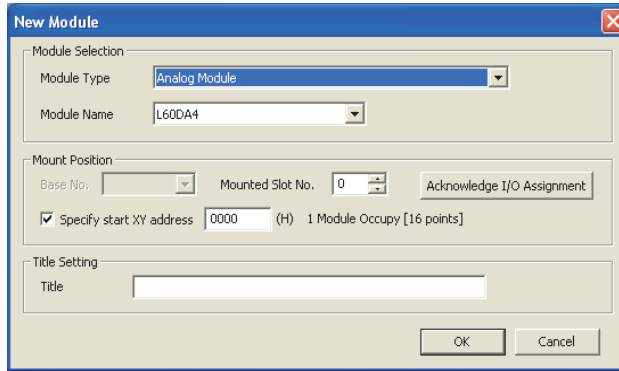
 Project window ⇨ Right-click [Intelligent Function Module] ⇨ [New Module]



Item		Description	Setting range
Module Selection	Module Type	Select a module type.	 Manual for the intelligent function module used
	Module Name	Select a model name.	
Mount Position	Mounted Slot No.	Select the number of the slot where an intelligent function module is connected.	
	 Acknowledge I/O Assignment button	Click this button to check I/O assignment setting of PLC parameter.	
	Specify start XY address	Enter the start I/O number.	
Title Setting	Title	Enter a title displayed in the Project window.	

After these parameters are set, a folder is created under the "Intelligent Function Module" folder in the Project window.

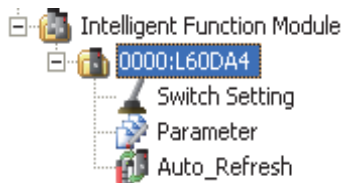

### Point

X, Y, and W can be set as an auto refresh device.

# CHAPTER 8 CYCLIC TRANSMISSION

This chapter describes how to perform cyclic transmission of bit and word device data of the head module.

## 8.1 Cyclic Transmission of Bit Device Data

The input (X) and output (Y) data of the modules connected to the head module can be used just like those of the master station by performing cyclic transmission.

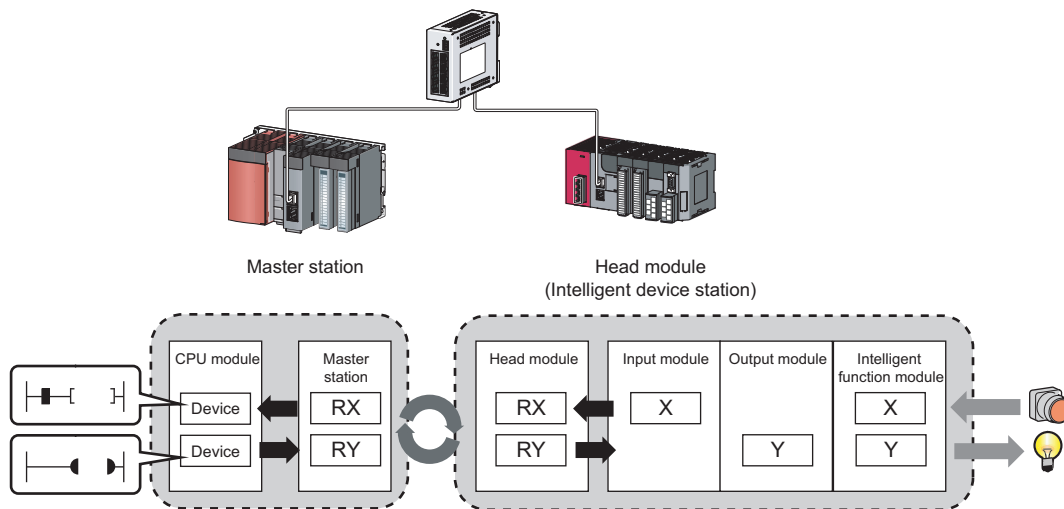

## (1) Data flow

This section describes the cyclic transmission data flow of bit device data and the setting for transmission.

- When data is input from an intelligent device station to the master station  
The input (X) data of each module connected to the head module is input to the remote input (RX) of the master station.
- When data is output from the master station to the intelligent device station  
The remote output (RY) data of the master station is output to the output (Y) of each module connected to the head module.

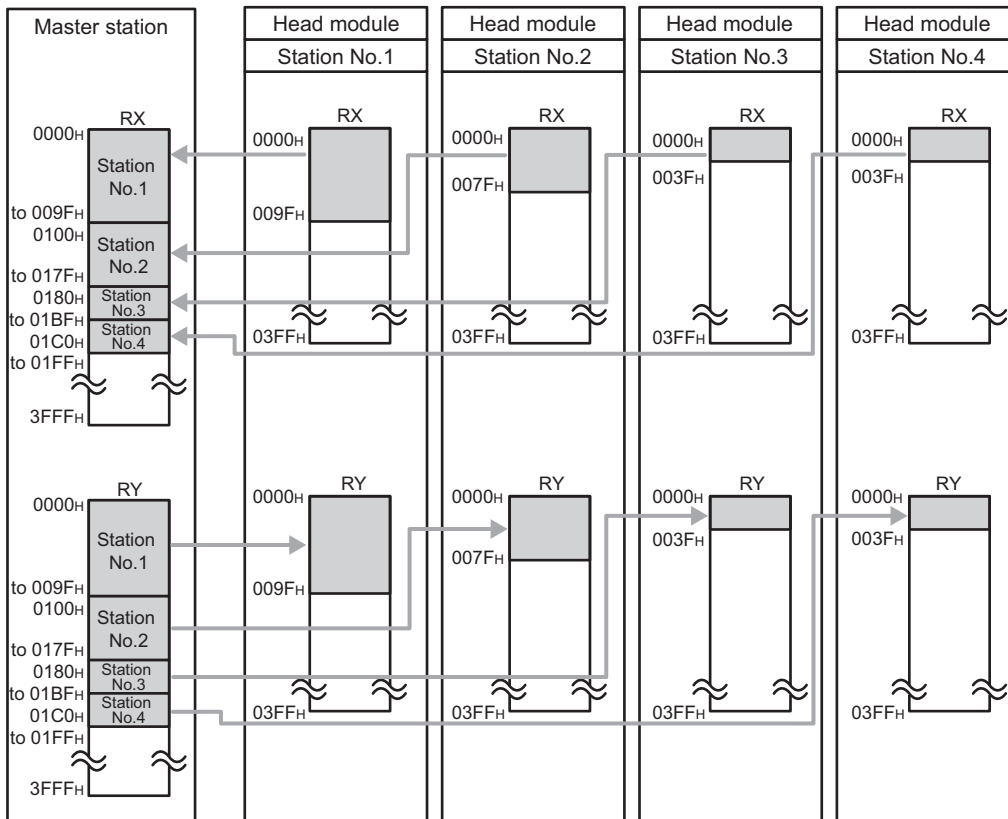

The I/O data flow between the master station and the head module (station number 1) is shown in Page 67, Section 8.1 (1) (a) and Page 68, Section 8.1 (1) (b).

(a) Data flow when "0000H" is set to the start number of RX/RX of the master station and the default I/O assignment setting for the head module is used

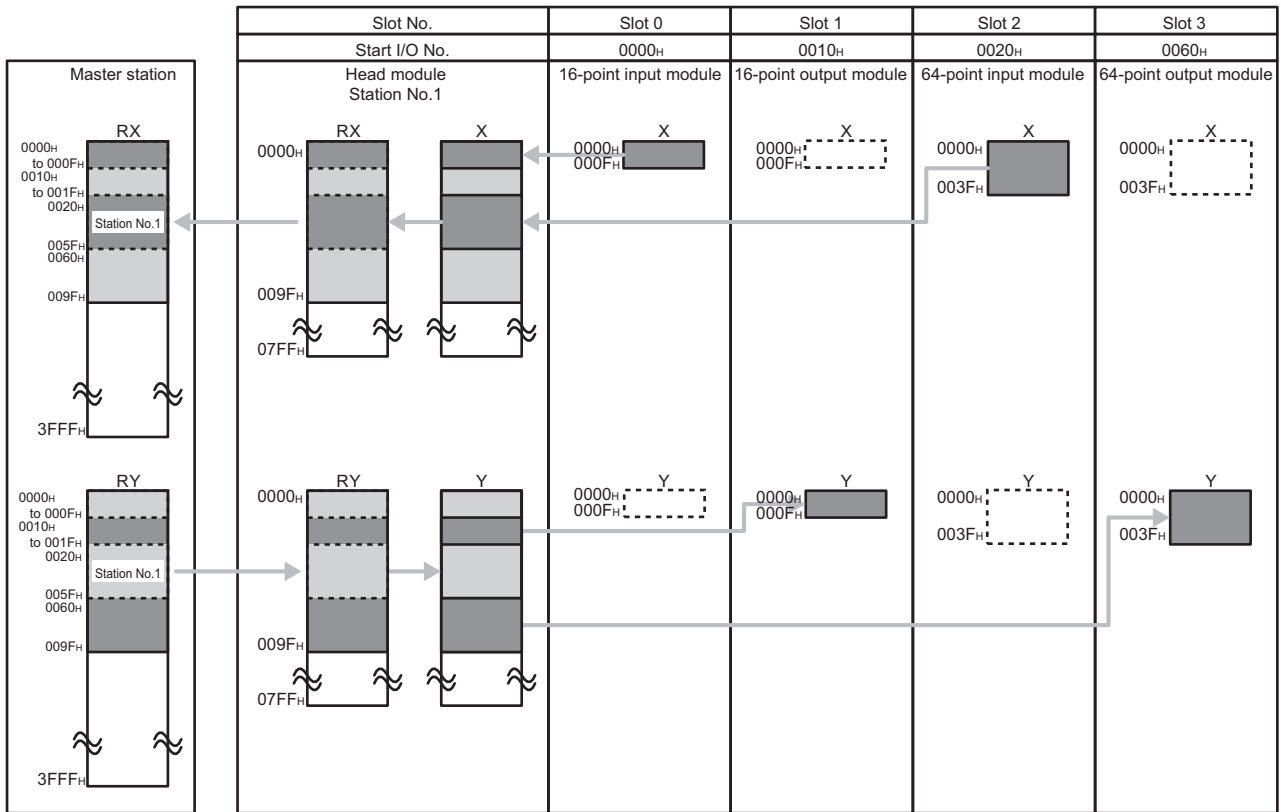

**(b) Data flow when "0000H" is set to the start number of RX/RX of the master station and the I/O assignment setting for the head module is changed**

The I/O assignment setting is changed as shown below in this example.

I/O Assignment

No.	Slot	Type	Model Name	Points	Start XY
0	Communication Head	Communication Head			
1	0(*-0)	Input	LX40C6	16Points	0020
2	1(*-1)	Output	LY10R2	16Points	0000
3	2(*-2)	Input	LX40C6	16Points	0030
4	3(*-3)	Output	LY10R2	16Points	0010
5	4(*-4)				
6	5(*-5)				
7	6(*-6)				

Switch Setting  
Detailed Setting

Assigning the I/O address is not necessary as the CPU does it automatically.  
Leaving this setting blank will not cause an error to occur.

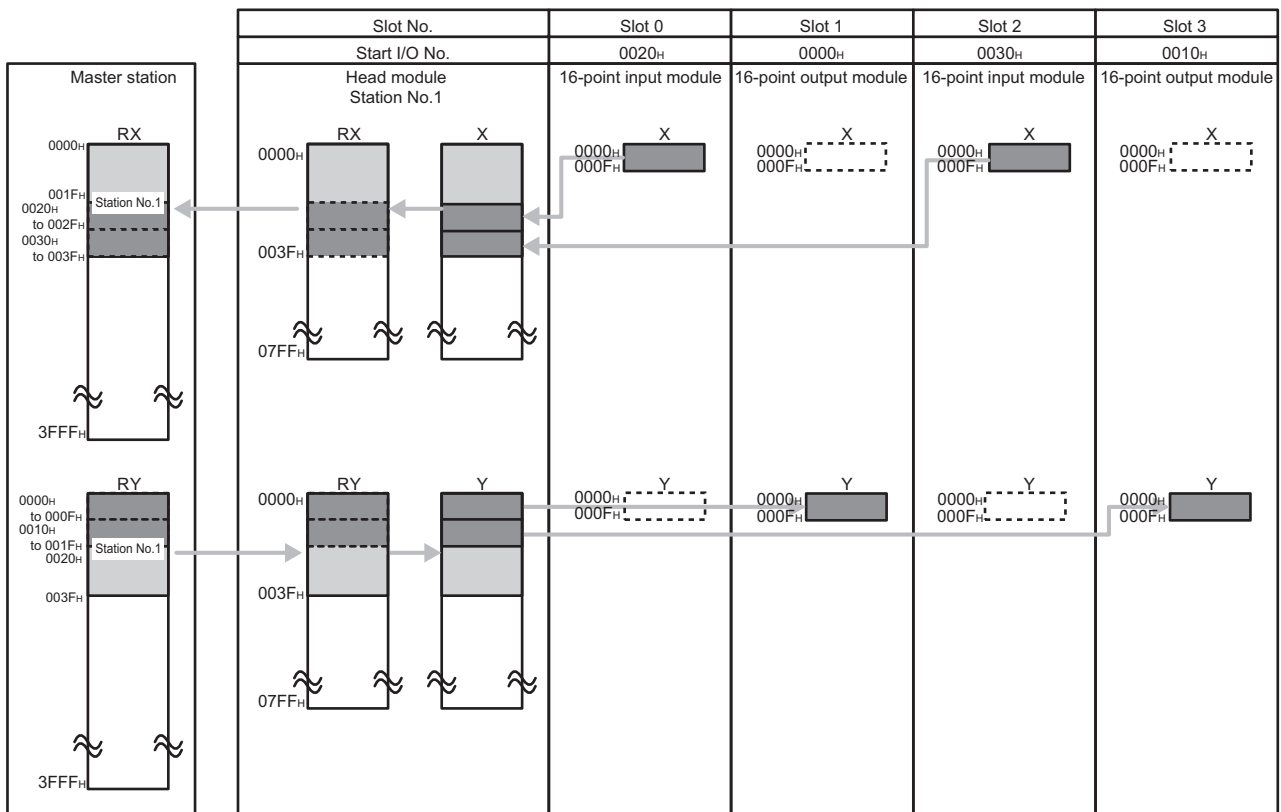

## (2) Data setting method

In Network Configuration Setting of the master station, set the total number of points for the input/output (X/Y) of the modules connected to the head module, in 16-point units.

In the case of the figure on the previous page, specify "0000" to "003F" for "RX/RX Setting".

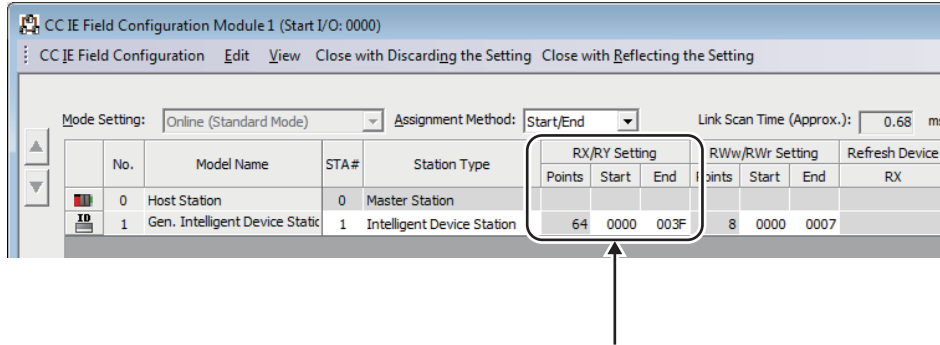

### Point

- To set an empty slot on the intelligent device station or to change a start I/O number, modify the data in the I/O Assignment setting of the head module.

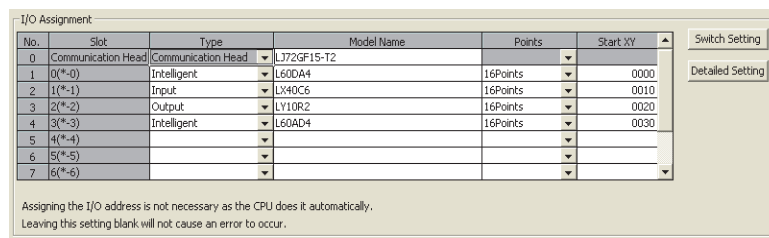













- If the number of points will be increased for a system expansion in future, for example, set a large number for "RX/RX Setting" in Network Configuration Setting of the master station. Doing so will eliminate the need to change the parameter setting of the master station at the time of the system expansion. However, increasing the number of points also increases the processing time.

### (3) Output status for each status

Depending on the status of the data link and head module, data may not be able to be output.

The following table summarizes how the status of the data link and head module affect the output (Y).

—: Not dependent on the status

Switch	Head module status	Data link status	Output (Y) status
RUN	Operating normally	Cyclic transmission being performed	<p>The output differs depending on the status and setting of the master station. (  User's manual for the master/local module used)</p> <p>(1) When the CPU module on the master station is in the stop error state: The output (Y) status is determined by the "Error Time Output Mode" setting of PLC parameter. (  Page 61, Section 7.1 (6)) The analog output status from the digital-analog converter module and the analog I/O module is determined by the setting of the analog output HOLD/CLEAR function.  MELSEC-L Digital-Analog Converter Module User's Manual  MELSEC-L Analog Input/Output Module User's Manual</p> <p>(2) When the CPU module on the master station is in the STOP state: The output (Y) is determined by the refresh parameters (refresh device of RY for the head module) of the master station. · If "Y" is specified for the device of the CPU module, the output (Y) of the head module turns off. · If "other than Y (such as M, L)" is specified for the device of the CPU module, the output (Y) of the head module depends on the "Output Setting During CPU STOP" setting of the master station. The analog output status from the digital-analog converter module and the analog I/O module is determined by the setting of the analog output HOLD/CLEAR function.  MELSEC-L Digital-Analog Converter Module User's Manual  MELSEC-L Analog Input/Output Module User's Manual</p>
RUN	Operating normally	Cyclic transmission stopped	<p>The output (Y) status is determined by the "Error Time Output Mode" setting of PLC parameter. (  Page 61, Section 7.1 (6)) The analog output status from the digital-analog converter module and the analog I/O module is determined by the setting of the analog output HOLD/CLEAR function.  MELSEC-L Digital-Analog Converter Module User's Manual  MELSEC-L Analog Input/Output Module User's Manual</p>
RUN	Operating normally	Disconnected	<p>The output (Y) is held for two seconds after the communication with the master station is terminated due to a problem such as disconnection of the Ethernet cable. The output (Y) status after disconnection is determined by the "Error Time Output Mode" setting of PLC parameter. (  Page 61, Section 7.1 (6))</p>
—	Error	—	<p>The output (Y) status is determined by the "Error Time Output Mode" setting of PLC parameter. (  Page 61, Section 7.1 (6))</p>
STOP	Operating normally	—	<p>The analog output status from the digital-analog converter module and the analog I/O module is determined by the setting of the analog output HOLD/CLEAR function.  MELSEC-L Digital-Analog Converter Module User's Manual  MELSEC-L Analog Input/Output Module User's Manual The output (Y) turns off.</p>



## 8.2 Cyclic Transmission of Word Device Data

Word data, such as data stored in the buffer memory of the module connected to the head module, can be used in the word device of the master station by performing cyclic transmission.

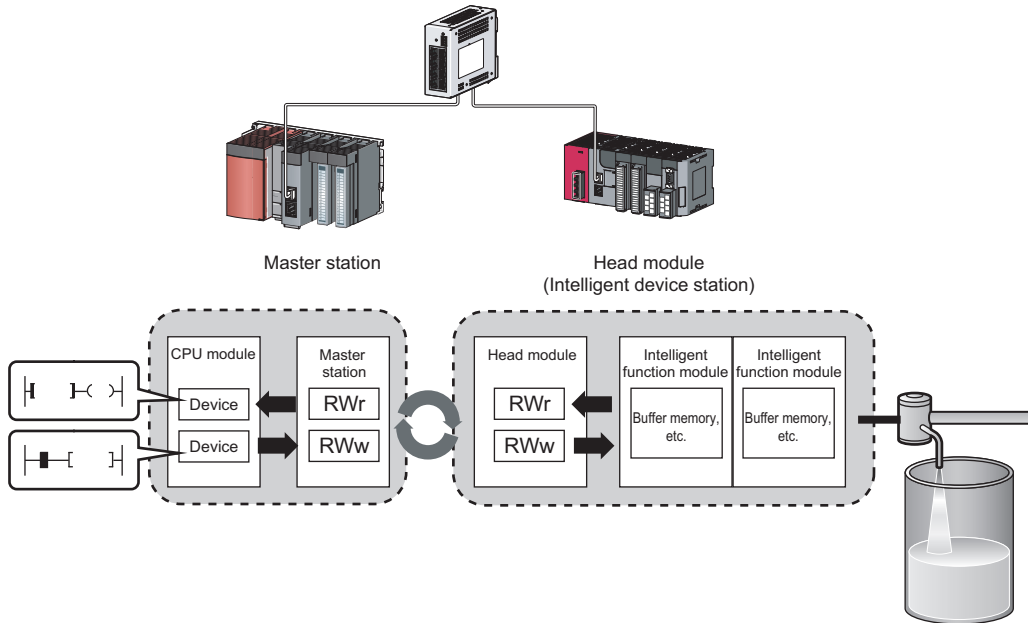

## (1) Data flow

This section describes the cyclic transmission data flow of word device data and the setting for transmission.

- When data is transferred from the master station to the intelligent device station  
The remote register (RWw) data of the master station is transferred to the buffer memory of the intelligent function module connected to the head module.
- When data is transferred from an intelligent device station to the master station  
The buffer memory data of the intelligent function module connected to the head module is transferred to the remote register (RWr) of the master station.

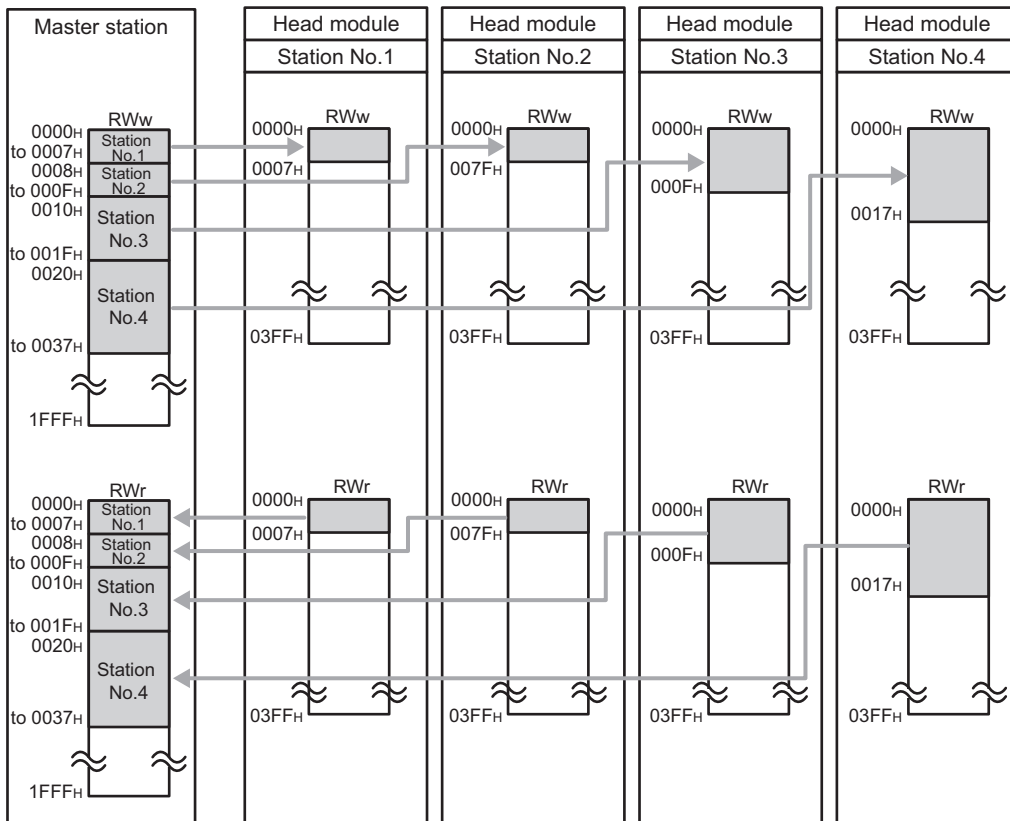

The data flow between the master station and the head module (station number 1) is shown in Page 73, Section 8.2 (1) (a).

(a) Data flow when "0000H" is set to the start number of RWw/RWr of the master station

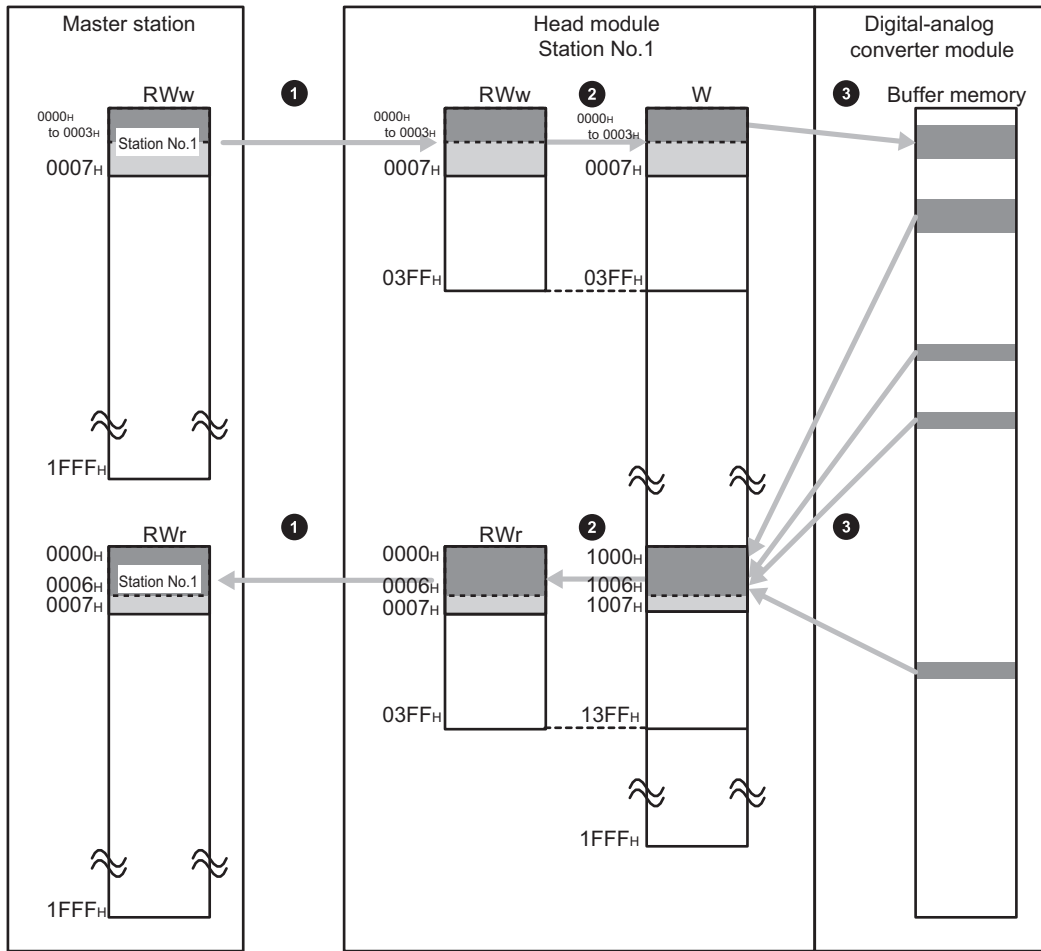

- ① Set RWw/RWr ranges transferred to the head module in the Network Configuration Setting of the master station. (☞ Page 74, Section 8.2 (2), step 2)
- ② Assign 1024 points (W0 to W3FF) from RWw0.  
Assign 1024 points (W1000 to W13FF) from RWr0.
- ③ Set the refresh ranges for the head module and the buffer memory of the intelligent function module in the auto refresh setting. (☞ Page 74, Section 8.2 (2), step 1)

## (2) Data setting method

1. Set the auto refresh of the intelligent function module connected to the head module.

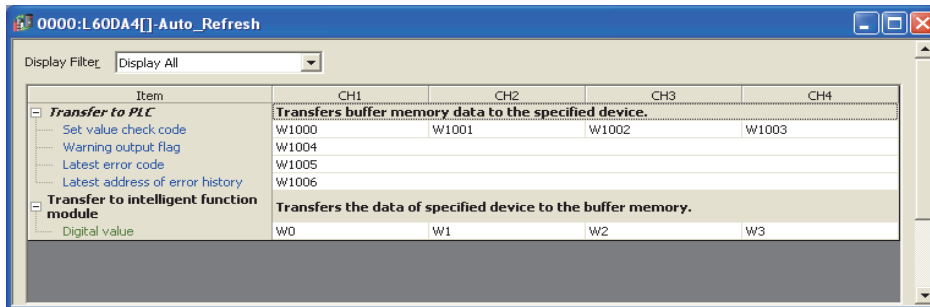

Specify the following devices as the devices to be auto refreshed.

Item	Setting range of auto refresh target device
"Transfer to PLC"	W1000 to W13FF
"Transfer to intelligent function module"	W0 to W3FF

2. In the Network Configuration Setting of the master station, set the number of RWw/RWr points assigned to the head module.

The number of points should be higher than the number of points set for auto refresh in step 1 above. (Set the number of points whichever is greater between "Transfer to CPU" and "Transfer to intelligent function module".)

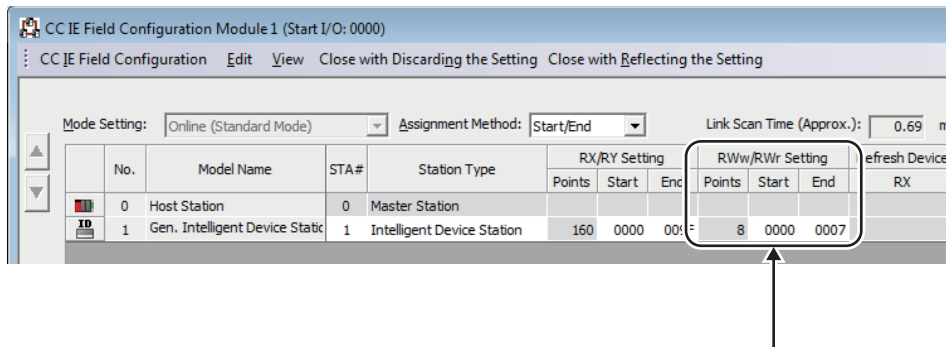

### Point

If the number of points will be increased for a system expansion in future, for example, set a large number for "RWw/RWr Setting" in Network Configuration Setting of the master station. Doing so will eliminate the need to change the parameter setting of the master station at the time of the system expansion. However, increasing the number of points also increases the processing time.

# CHAPTER 9 CC-LINK IE FIELD NETWORK DIAGNOSTICS

This chapter describes how to check error locations and causes by executing the CC-Link IE Field Network diagnostics using GX Works2.

When GX Works2 is connected to the master station, the entire network status can be monitored. If the intelligent device station status cannot be monitored due to cable disconnection or any other error, directly connect GX Works2 to the head module.

This chapter describes a method for diagnosing the system by directly connecting GX Works2 to the head module. For the method connecting GX Works2 to the master station, refer to the following.

 User's manual for the master/local module used

## 9.1 Diagnostic Items

The following window shows items that can be diagnosed by CC-Link IE Field Network diagnostics (when GX Works2 is connected to the head module).

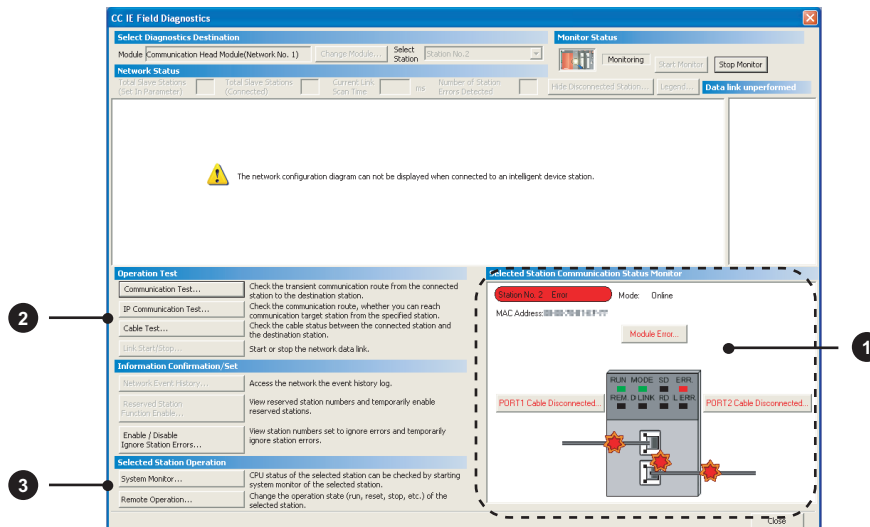

	Item	Reference
1	Display of the head module status and error details	Page 78, Section 9.3
2	Communication test	Page 80, Section 9.4
	Cable test	Page 80, Section 9.5
3	System monitor	Page 81, Section 9.6
	Remote operation	Page 81, Section 9.7

## 9.2 Starting Diagnostics

This section describes how to execute the CC-Link IE Field Network diagnostics.

1. Connect GX Works2 to the head module.
2. Start the CC-Link IE Field Network diagnostics from the menu.

 [Diagnostics] ⇨ [CC IE Field Diagnostics]

### Point

- When another station has been specified as a connected station  
The CC-Link IE Field Network diagnostics cannot be started when another station has been specified in "Other Station Setting" of the "Transfer Setup" window. In this case, directly connect GX Works2 to the head module.
- Start from the "PLC Diagnostics" window  
The CC-Link IE Field Network diagnostics can also be started from the "PLC Diagnostics" window.

1. With the mouse, select the connector to which the Ethernet cable is connected.

2. Click "CC-Link IE Field Diagnostics" appearing on the right side.

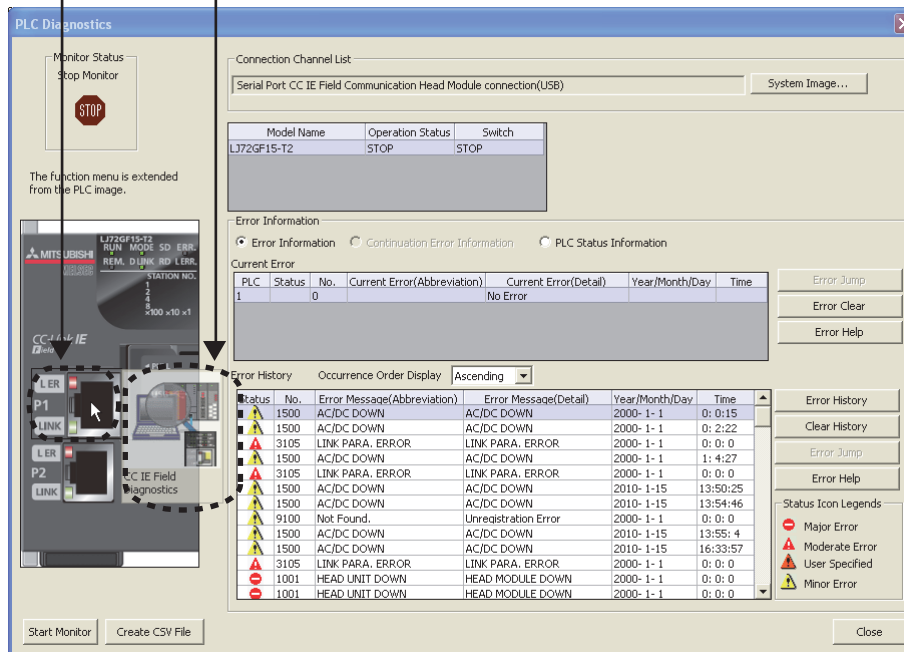

**3. The head module status is displayed in "Selected Station Communication Status Monitor". (👉 Page 78, Section 9.3)**

If an error occurs, a button indicating the error (e.g. PORT2 Communication Error... button) is displayed. Click the button to check the error details and actions to be taken.

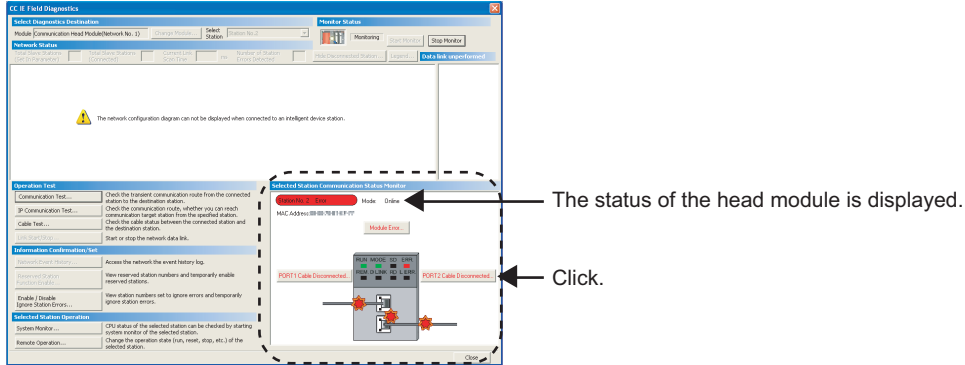

**4. Various tests and operations can be performed from "Operation Test" and "Selected Station Operation" on the bottom left of the window. (👉 Page 80, Section 9.4 to Page 81, Section 9.7)**

Various tests and operations can be performed.

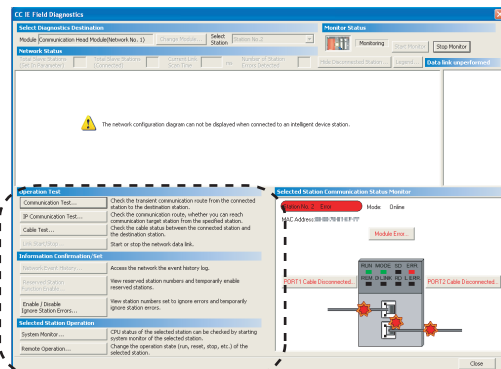



## 9.3 Diagnostic Window



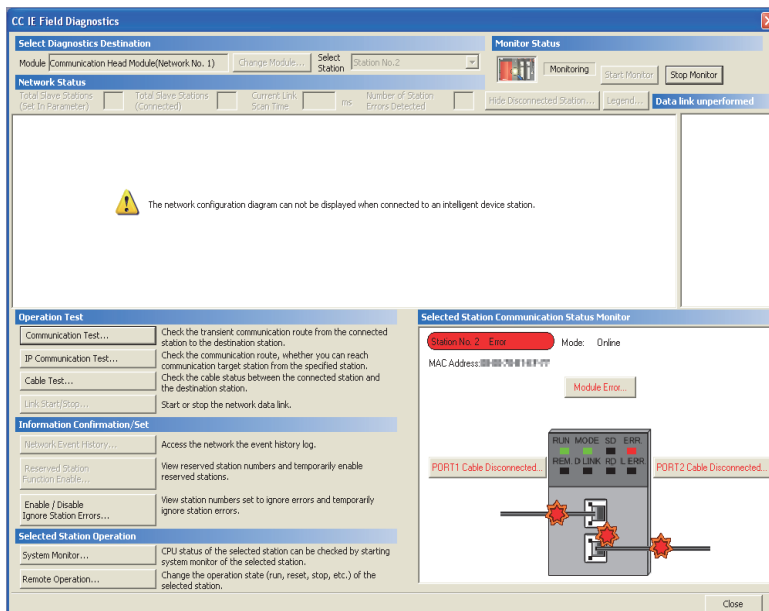



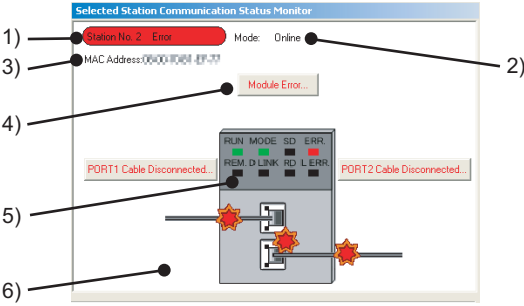
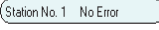
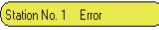

This section describes items displayed in the "CC IE Field Diagnostics" window.

### (1) Displayed items

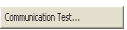

Item		Description
Monitor Status	 button	Starts monitoring of the CC-Link IE Field Network diagnostics.
	 button	Stops monitoring of the CC-Link IE Field Network diagnostics.

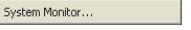

Item	Description
Selected Station Communication Status Monitor	Displays the head module status. 
	Displays the operating status. <ul style="list-style-type: none"> <li>1)  : Operating normally</li> <li> : Error (Data link continued) (yellow)</li> <li> : Error (Data link stopped) (red)</li> </ul>
	2) Displays the mode.
	3) Displays the MAC address.
	4) Click this button to check error details. Take actions following the description displayed in "Error Factor" and "Troubleshooting".
	5) Displays the LED status of the head module and the communication status of PORT1 and PORT2. (☞ Page 20, CHAPTER 2)
Displays the status of the cables connected to PORT1 and PORT2. <ul style="list-style-type: none"> <li>6)  : Properly connected</li> <li> : Error (cable disconnection)</li> <li> : Error (other than cable disconnection)</li> </ul>	
Operation Test	 button Performs a communication test. (☞ User's manual for the master/local module used)
	 button Performs a cable test. (☞ User's manual for the master/local module used)
Selected Station Operation	 button Opens the System Monitor window. (☞ Page 89, Section 11.3)
	 button Performs remote operations (such as remote RUN, STOP, and RESET) to the head module. (☞ Page 81, Section 9.7)

## 9.4 Communication Test

Communication test checks if transient transmission data can be properly routed from the own station to the communication target. For how to perform a test, refer to the following.

 User's manual for the master/local module used

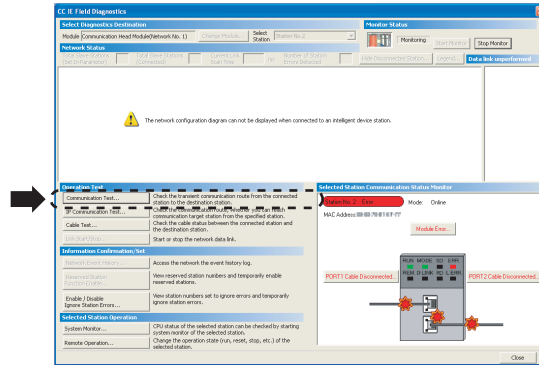

## 9.5 Cable Test

Cable test checks if the Ethernet cables are properly connected. Only the Ethernet cable connected to the PORT1 or PORT2 of the target station is tested. For how to perform a test, refer to the following.

 User's manual for the master/local module used

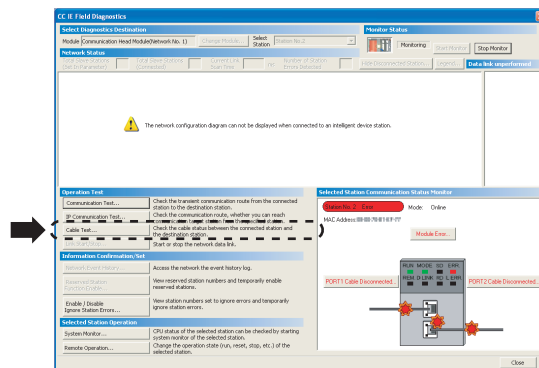

# 9.6 System Monitor

The "System Monitor" window opens. Errors that occur in modules other than the head module can also be checked. For details, refer to  Page 89, Section 11.3.

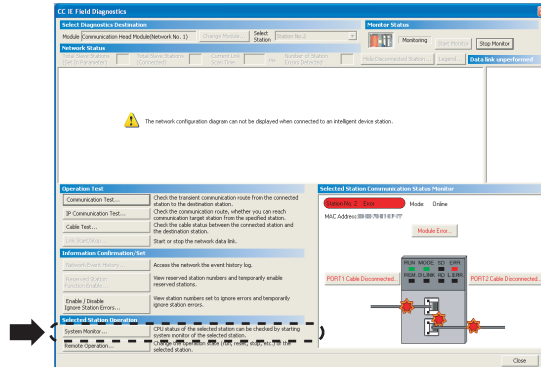

# 9.7 Remote Operation

Remote operations (such as remote RUN, STOP, and RESET) can be performed from GX Works2 to the head module.

1. Connect GX Works2 to the head module.
2. Start the CC-Link IE Field Network diagnostics from the menu.

 [Diagnostics] ⇨ [CC IE Field Diagnostics]

3. Click the  button in the "CC IE Field Diagnostics" window.

The "Remote Operation" window opens.

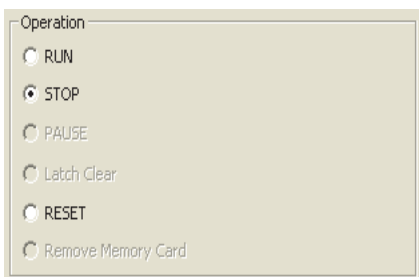
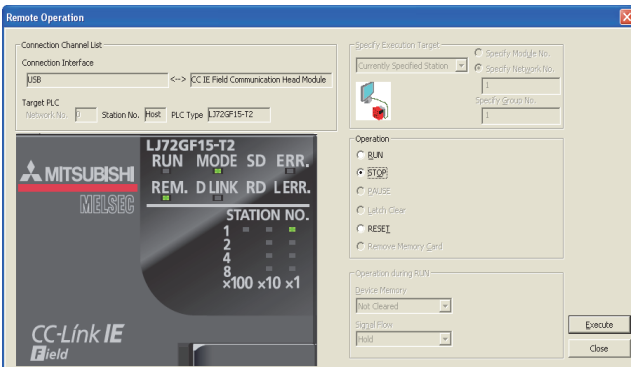

4. Select a remote operation to the head module in "Operation".

Item	Description
RUN	Select a remote operation to the head module. • If remote RUN is performed when the switch of the head module is set to STOP or the master station is in STOP status (including disconnected status), the head module will not enter RUN status. • If remote RESET is performed when the switch of the head module is set to RUN, the head module will not be reset.
STOP	
RESET	

5. Click the  button to perform the remote operation.

# CHAPTER 10 MAINTENANCE AND INSPECTION

---

This chapter describes items that must be maintained or inspected daily or periodically to properly use a programmable controller in optimal condition at all times.

## 10.1 Daily Inspection

---

This section describes items that must be inspected daily.

Check box

The modules are securely installed.

The module joint levers are properly locked.

The terminal screws of the modules are properly tightened.

Solderless terminals are physically out of contact and away from each other.

Cable connectors are fully inserted.

The terminal cover of the power supply module is securely attached.

## 10.2 Periodic Inspection

---

This section describes items that must be inspected once or twice every 6 to 12 months.

The items must be inspected as well when the equipment has been relocated or modified, or wiring layout has been changed.

**10**

Check box

- The ambient temperature is within 0 to 55 °C.
- The ambient humidity is within 5 to 95%RH.
- There is no corrosive gas.
- The voltage across 100VAC terminals is within 85V to 132VAC.
- The voltage across 200VAC terminals is within the range of 170V to 264VAC.
- The voltage across 24VDC terminals is within 15.6V to 31.2VDC.
- The modules are securely installed.
- No dust or foreign matter is present.
- No error has occurred.

# CHAPTER 11 TROUBLESHOOTING

---

This chapter describes errors that may occur in the head module, causes of the errors, and corrective actions.

## 11.1 Before Troubleshooting

---

Check that the POWER LED of the power supply module is on. If it is off, troubleshoot the CPU module.

(  MELSEC-L CPU Module User's Manual (Hardware Design, Maintenance and Inspection) )

## 11.2 Troubleshooting Procedure

---

This section describes the procedure for identifying the cause of the problem and taking action.

GX Works2 is used for this. When GX Works2 is connected to the master station, the entire network status can be monitored. If the head module status cannot be monitored due to cable disconnection or any other error, directly connect GX Works2 to the head module.

This section describes the troubleshooting procedure taken when GX Works2 is directly connected to the head module.

## (1) Procedure

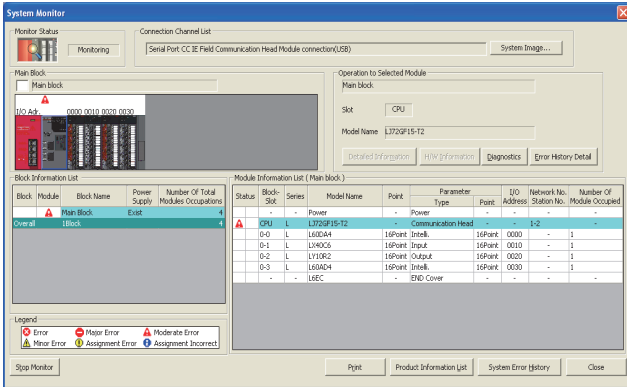

1. Connect GX Works2 to the head module, and open the "System Monitor" window.

[Diagnostics] ⇨ [System Monitor]

2. Select the module in which an error has occurred.

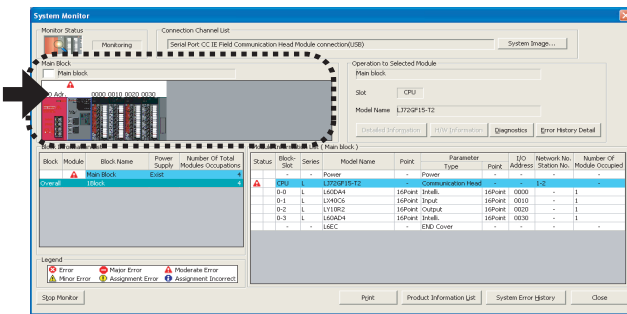

- When the selected module is the head module

Page 86, Section 11.2 (1) (a)

- When the selected module is a module other than the head module

Page 88, Section 11.2 (1) (b)



When data link cannot be performed even though no error is shown in the "System Monitor" window, execute the CC-Link IE Field Network diagnostics. ( Page 75, CHAPTER 9)

## (a) Checking for an error of the head module

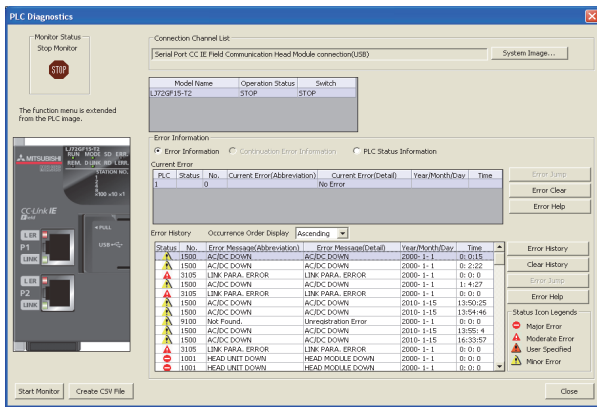

1. Select the head module in the "System Monitor" window and click the **Diagnostics** button to open the "PLC Diagnostics" window.

How to start CC-Link IE field network diagnostics

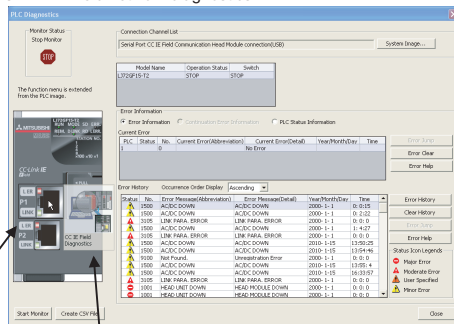

- 1) Place the mouse pointer on the port to be diagnosed.
- 2) The CC-Link IE Field Diagnostics icon appears. Click the icon.

2. Select the error that is occurring, and click the **Error Help** button to check the cause and action.

When data link cannot be performed even though no error is shown in the "PLC Diagnostics" window, open the CC-Link IE Field Network diagnostics window by the operation described left and take action. (Page 75, CHAPTER 9)

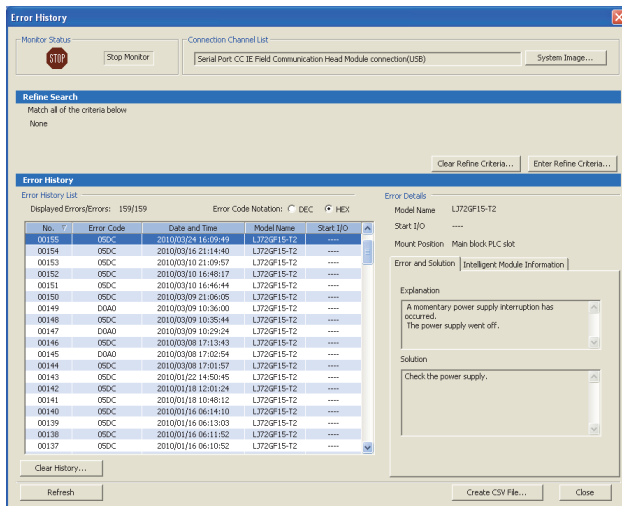



3. Check the error that has occurred before the head module is reset or the system is powered off in the "Error History" window.

[Diagnostics] ⇨ [System Monitor] ⇨ **System Error History** button

In the "Error History" window, the error history of both the head module and intelligent function modules can be viewed. (Page 89, Section 11.3)



**4. If data link cannot be performed even after troubleshooting by the above operation, perform the following.**

- CC-Link IE Field Network diagnostics by connecting GX Works2 to the master/local module (  User's manual for the master/local module used)
- Checking the LEDs (  Page 91, Section 11.4)
- Troubleshooting by symptom (  Page 95, Section 11.5)

## (b) Checking for an error of a module other than the head module

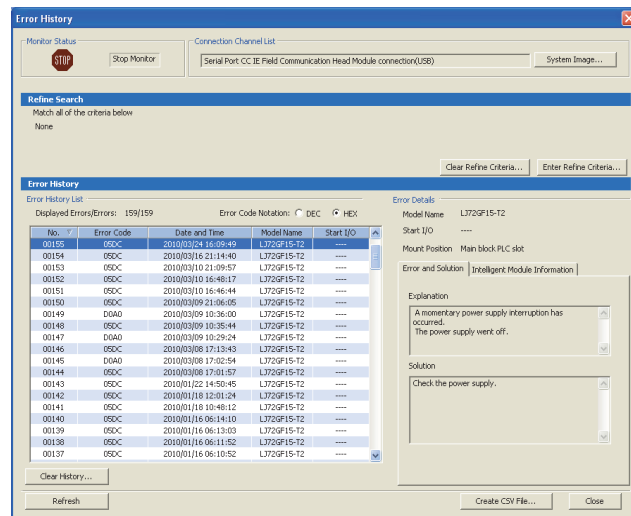
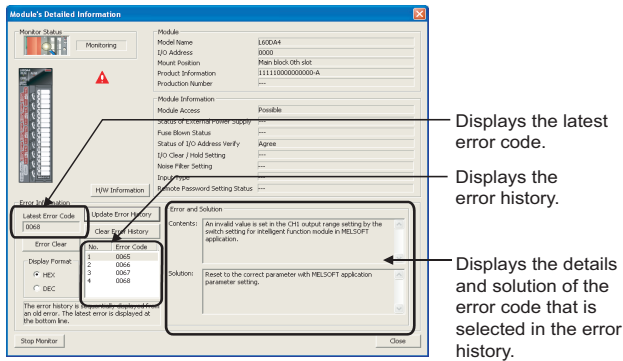

1. Select a module other than the head module in the "System Monitor" window, and click the **Diagnostics** or **Detailed Information** button to view the diagnostics or detailed information.

2. Check the error that has occurred before the head module is reset or the system is powered off in the "Error History" window.

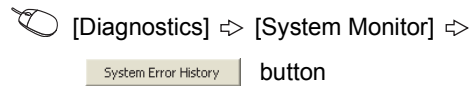

In the "Error History" window, the error history of both the head module and intelligent function modules can be viewed. (Page 89, Section 11.3)

3. If data link cannot be performed even after troubleshooting by the above operation, perform the following.

- Checking the LEDs (Page 91, Section 11.4)
- Troubleshooting by symptom (Page 95, Section 11.5)

# 11.3 System Error History

The history of the errors that occurred in the past can be checked so that corrective actions can be taken for each of them. The error that has occurred before the head module is reset or the system is powered off also can be checked. On a single window, the error history of not only the head module but also the intelligent function modules connected to the head module can be checked.

Data of up to 100 errors can be collected. (When the number of collected error logs exceeds 100, the oldest error log will be deleted.)

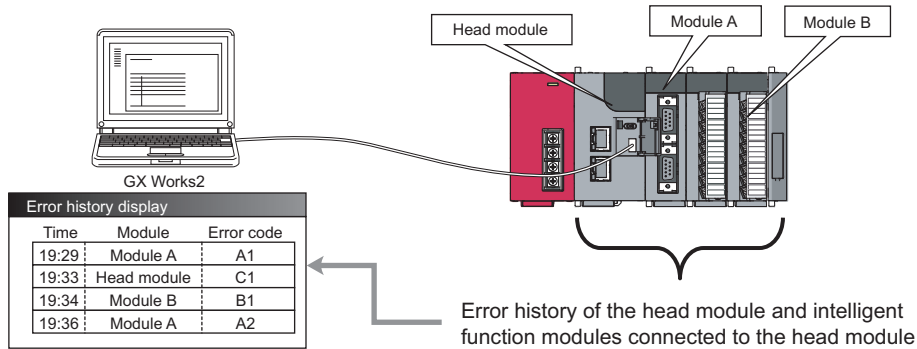

## (1) Checking the error history

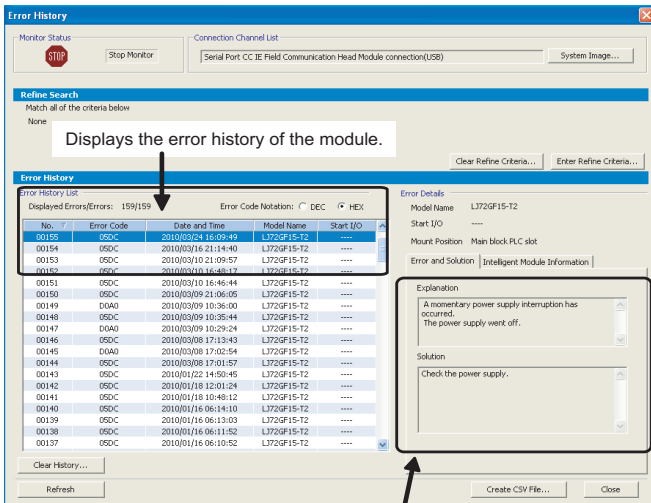

Displays the details and solution of the error selected in "Error History List."

### 1. Open the "Error History" window.

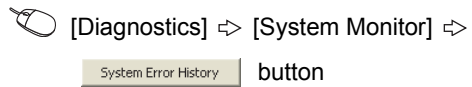

The error history is displayed. Check the error and corrective action, and troubleshoot the problem.

### Point

- If the error code 9900 is detected, check the error and corrective action of the error code D\*\*\*H detected at the same time to troubleshoot the problem. Concurrently with the error code 9900, the error code D\*\*\*H is also detected.
- If the same error occurred continuously, only the first error record is displayed in the "Error History" window.
- Selecting a module in the "Main Block" area in "System Monitor" and clicking the **Error History Detail** button will also open the "Error History" window. In this case, only the error history of the module selected in "Main Block" is displayed. For details on errors of intelligent function modules, refer to the following.

Manual for the intelligent function module used

## (2) Precautions

### (a) When the time and date of the error is not correctly displayed

- Check if the master station is connected to the head module. The head module periodically collects time information from the CPU module on the master station. If the master station is not connected to the head module, the time and date of errors will not be displayed correctly. (Initial value: 2000/01/01 00:00:00)
- After acquisition of clock information from the master station, if the head module is powered off and on, the clock will restart from the time of the power off. (The clock pauses during power off.)  
Because of this, the displayed time and date of the error occurred during initial processing may be different from the actual time and date.

### (b) When the error code is not correctly displayed

If errors occur frequently, "\*\*HST.LOSS\*\*" may be displayed in the "Error Code" column, instead of an error code.

No.	Error Code	Date and Time	Model Name	Start I/O
00005	*HST.LOSS*	2010/03/30 11:51:41	LJ72GF15-T2	----
00004	0068	2010/03/30 11:51:45	L60DA4	0000

### (c) When no error history is displayed

Check if the "Module Error History Collection (Intelligent Function Module)" is selected in the "PLC RAS" setting of PLC parameter. This setting is enabled by executing the write to PLC function using GX Works2 and resetting the head module or powering off and on the system.

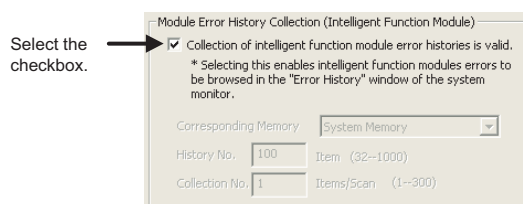

## Point

If the "Module Error History Collection (Intelligent Function Module)" checkbox is not selected, error history data of intelligent function modules are not collected.

Clear the checkbox if a higher operation speed is desired for the head module.

# 11.4 Checking the LEDs

This section describes troubleshooting using the LEDs.

## (1) When the RUN LED turns off

Check item	Action
Is the head module installed correctly?	Connect the head module to the power supply module again.

If the above action does not solve the problem, perform a unit test on the head module to check for a hardware failure. (☞ Page 45, Section 6.4)

## (2) When the RUN LED flashes

Check item	Action
Is the switch on the head module set to "RUN"?	Set the switch on the head module to RUN to start data link.
Is it in the remote STOP state?	Cancel the remote STOP state and start data link.
Has an error occurred in the head module?	Identify the error cause on the "System Monitor" window using GX Works2, and take action. (☞ Page 84, Section 11.2)
Is the master station in the RUN state?	Set the operating status of the master station to RUN. If the master station has stopped due to an error, troubleshoot it referring to the manual for the master station. (📖 User's manual for the master/local module used)
Was the head module disconnected during STOP of the master station?	<ul style="list-style-type: none"> <li>• Set the operating status of the master station to RUN and reconnect the head module to the network.</li> <li>• Reset the head module because it retains the STOP status of the master station.</li> </ul>

## (3) When the MODE LED turns off

Check item	Action
Is the mode of the head module set to Online?	Change the mode to Online. (☞ Page 53, Section 7.1 (1))





If the above action does not solve the problem, perform a unit test on the head module to check for a hardware failure. (☞ Page 45, Section 6.4)

## (4) When the MODE LED flashes



Check item	Action
Is the head module in preparation for the unit test?	If the switch on the head module was repeatedly switched between STOP and RESET/TEST, reset the head module and start the unit test.
Is the head module in execution of the unit test? (The $\times 1$ or $\times 10$ LED is flashing.)	The head module is in execution of the unit test. Upon completion of the unit, the D LINK LED turns on. Take action according to the unit test result. (☞ Page 45, Section 6.4 (1))
Is the mode of the module on the master station set to Online?	Change the mode to Online. (📖 User's manual for the master/local module used)

If the above actions do not solve the problem, perform a unit test on the head module to check for a hardware failure. (☞ Page 45, Section 6.4)

## (5) When the D LINK LED turns off

Check item	Action
Is the master station connected to the network and operating normally?	<ul style="list-style-type: none"> <li>• If an error has occurred in the CPU module on the master station, eliminate the cause of the CPU module error. (  User's manual for the master/local module used)</li> <li>• Connect GX Works2 to the master station, and check if the master station is performing data link by executing the CC-Link IE Field Network diagnostics. (  User's manual for the master/local module used)</li> </ul>
Are the Ethernet cables correctly used and connected?	<ul style="list-style-type: none"> <li>• Check if 1000BASE-T-compliant Ethernet cables are used. (  Page 26, Section 3.2)</li> <li>• Check if the station-to-station distance is 100m or less. (  Page 50, Section 6.5.3)</li> <li>• Check if the Ethernet cables are not disconnected.</li> </ul>
Are the switching hub and other stations connected to the head module operating normally?	Check if the switching hub and other stations are powered on.
Is the switching hub used in the system operating normally?	Check if a 1000BASE-T-compliant switching hub is used. (  User's manual for the master/local module used)
Isn't the station number of the head module overlapping with any of the other stations?	Change the station number so that it does not overlap.
Does the network number of the head module match that of the connected network?	Match the network number of the head module to that of the connected network.

If the above actions do not solve the problem, perform the following tests on the head module to check for an error.

- Unit test (  Page 45, Section 6.4)
- Cable test (  Page 80, Section 9.5)

## (6) When the D LINK LED flashes

Check item	Action
Are the STATION NO. LEDs of the head module correctly showing the station number specified in Network Configuration Setting of the master station?	<ul style="list-style-type: none"> <li>• Have the station number of the actual head module and the one specified in Network Configuration Setting of the master station matched.</li> <li>• Execute the format PLC memory function to the head module using GX Works2, and then write PLC parameters again.</li> </ul>

If the above actions do not solve the problem, connect GX Works2 to the master station and execute the CC-Link IE Field Network diagnostics. (  User's manual for the master/local module used)

## (7) When the ERR. LED turns on

Identify the cause of the error using GX Works2, and take action. (  Page 84, Section 11.2)

**(8) When the L ERR. LED turns on**

Check item	Action
Are the Ethernet cables correctly used and connected?	<ul style="list-style-type: none"> <li>• Check if 1000BASE-T-compliant Ethernet cables are used. (☞ Page 26, Section 3.2)</li> <li>• Check if the station-to-station distance is 100m or less. (☞ Page 50, Section 6.5.3)</li> <li>• Check if the Ethernet cables are not disconnected.</li> </ul>
Is the switching hub used in the system operating normally?	<ul style="list-style-type: none"> <li>• Check if a 1000BASE-T-compliant switching hub is used. (📖 User's manual for the master/local module used)</li> <li>• Check if the switching hub is powered on.</li> </ul>
Are other stations connected to the head module operating normally?	Check the operating status of modules on other stations.
Is the mode of the module on the master station set to Online?	Change the mode to Online. (📖 User's manual for the master/local module used)
Is there any noise affecting the system?	Check the wiring condition.
Is the loopback function enabled for the master station?	When the loopback function is enabled, check if the ring topology is correctly configured for the port where the L ERR. LED is on. (📖 User's manual for the master/local module used)

If the above actions do not solve the problem, perform the following tests on the head module to check for an error.

- Unit test (☞ Page 45, Section 6.4)
- Cable test (☞ Page 80, Section 9.5)

**(9) When the LINK LED turns off**

Check item	Action
Are the Ethernet cables correctly used and connected?	<ul style="list-style-type: none"> <li>• Check if 1000BASE-T-compliant Ethernet cables are used. (☞ Page 26, Section 3.2)</li> <li>• Check if the station-to-station distance is 100m or less. (☞ Page 50, Section 6.5.3)</li> <li>• Check if the Ethernet cables are not disconnected.</li> </ul>
Does the cabling condition (bending radius) meet the specifications?	Refer to the manual for the Ethernet cable used, and correct the bending radius to meet the specifications.
Are the switching hub and other stations connected to the head module operating normally?	Check if the switching hub and other stations are powered on.

If the above actions do not solve the problem, perform the following tests on the head module to check for an error.

- Unit test (☞ Page 45, Section 6.4)
- Cable test (☞ Page 80, Section 9.5)

**(10) When the REM. LED flashes**

Check item	Action
After execution of the write to PLC function, was the head module reset?	Reset the head module.
Are any forced I/O data being registered?	Cancel the registration.

### (11)When the REM. LED turns off

Check item	Action
Has an error occurred in the head module?	Identify the error cause on the "System Monitor" window using GX Works2, and take action. (☞ Page 84, Section 11.2)



## 11.5 Troubleshooting by Symptom

This section describes troubleshooting methods by symptom. Perform these troubleshooting actions when cyclic and/or transient transmissions are not possible with the target station even though no error is detected in the head module.

If an error has occurred in an intelligent function module installed with the head module, identify the cause of the error by using GX Works2. (☞ Page 84, Section 11.2)

### Point

- Before starting the troubleshooting by symptom, check that the POWER LED of the power supply module is on. For troubleshooting of the power supply module, refer to the  MELSEC-L CPU Module User's Manual (Hardware Design, Maintenance and Inspection) .
- When the troubleshooting by symptom cannot solve the problem Perform a unit test on the head module to check for a hardware failure. (☞ Page 45, Section 6.4)

### 11.5.1 When cyclic transmission cannot be performed

When cyclic data are not delivered to other stations, or when cyclic data from the master station cannot be received, perform the following troubleshooting.

Check item	Action
Is the D LINK LED of the head module on?	If the D LINK LED is flashing or off, perform the troubleshooting by the LEDs. (☞ Page 91, Section 11.4)
Are the I/O assignment settings of PLC parameter correct?	Set the I/O assignment correctly. (☞ Page 61, Section 7.1 (6))
Is the switch on the head module set to "RUN"?	Set the switch to "RUN".
Is the RUN LED of the head module on?	If the RUN LED is flashing or off, perform the troubleshooting by the LEDs. (☞ Page 91, Section 11.4)

If the above actions do not solve the problem, check the link device assignment of the master station and the refresh target device setting of refresh parameters for an error. (  User's manual for the master/local module used)

### 11.5.2 When transient transmission cannot be performed

If transient transmission cannot be performed with the target station, check if the network number and station number of the head module are correctly set. (☞ Page 53, Section 7.1 (1))

If the network number and station number are correctly set, refer to the troubleshooting for the master/local module, and take action. (  User's manual for the master/local module used)

## 11.6 List of Error Codes

---

This section describes error messages, error conditions, causes, and actions for respective error codes of the head module.

Errors of the head module are classified by error codes as shown below.

<b>Error code</b>	<b>Classification</b>	<b>Reference</b>
1 to 10000	Errors of the head module	Page 97, Section 11.6 (1)
4000H to 4FFFH	Error codes returned to the request source at communications	Page 103, Section 11.6 (2)
D000H to DFFFH	Errors of CC-Link IE Field Network	Page 103, Section 11.6 (3)

**(1) Error codes (1 to 10000)**

The following table lists the error messages, error conditions, causes, and actions of the error codes (1 to 10000). The "■Supplementary information" in the "Error and cause" column can be checked by any of the following.

- PLC diagnostics in GX Works2
- Error common information (SD5 to SD15)
- Error individual information (SD16 to SD26)

Error code	Error and cause	Action
1000		
1001	<b>[HEAD UNIT DOWN]</b>	
1002	The head module is running away or faulty.	
1003	• Malfunction due to noise	
1004	• Hardware failure	Take measures to reduce noise, and reset the module.
1005	■Supplementary information	If the the same error code is displayed again, the possible cause is a hardware failure of the head module. (Please consult your local Mitsubishi representative.)
1006	• Common information: -	
1009	• Individual information: -	
1035	■Diagnostic timing	
	• Any time	
1090	<b>[HEAD UNIT DOWN]</b>	
	The head module is running away or faulty.	
	• Malfunction due to noise	
	• Hardware failure	Take measures to reduce noise, and reset the module.
	■Supplementary information	If the the same error code is displayed again, the possible cause is a hardware failure of the head module. (Please consult your local Mitsubishi representative.)
	• Common information: -	
	• Individual information: Breakdown information	
	■Diagnostic timing	
	• Any time	
1101	<b>[RAM ERROR]</b>	
1102	The RAM built in the head module is faulty.	
1103	■Supplementary information	Take measures to reduce noise, and reset the module.
1104	• Common information: -	If the the same error code is displayed again, the possible cause is a hardware failure of the head module. (Please consult your local Mitsubishi representative.)
	• Individual information: -	
	■Diagnostic timing	
	• When powered on or reset	
1161	<b>[RAM ERROR]</b>	
	The data in the device memory built in the head module were overwritten.	
	■Supplementary information	Take measures to reduce noise, and reset the module.
	• Common information: -	If the the same error code is displayed again, the possible cause is a hardware failure of the head module. (Please consult your local Mitsubishi representative.)
	• Individual information: -	
	■Diagnostic timing	
	• Any time	
1310	<b>[I/O INT. ERROR]</b>	
	An interrupt occurred even though there is no module that can issue an interrupt.	
	■Supplementary information	The hardware of any of the installed modules may have failed. Check the modules, and replace the faulty module. (Please consult your local Mitsubishi representative.)
	• Common information: -	
	• Individual information: -	
	■Diagnostic timing	
	• When an interrupt occurred	
1311	<b>[I/O INT. ERROR]</b>	
	An interrupt request from a module installed with the head module was detected.	
	■Supplementary information	The hardware of any of the installed modules may have failed. Check the modules, and replace the faulty module. (Please consult your local Mitsubishi representative.)
	• Common information: -	
	• Individual information: -	
	■Diagnostic timing	
	• When an interrupt occurred	

Error code	Error and cause	Action
1401	<p><b>[SP. UNIT DOWN]</b></p> <ul style="list-style-type: none"> <li>In the initial processing, no response is returned from the intelligent function module.</li> <li>The buffer memory size of the intelligent function module is abnormal.</li> <li>No response is returned from the intelligent function module.</li> <li>When the error occurs, the start I/O number of the corresponding intelligent function module is stored in the common information area.</li> </ul> <p>■<b>Supplementary information</b></p> <ul style="list-style-type: none"> <li>Common information: Module No. (Slot No.)</li> <li>Individual information: -</li> </ul> <p>■<b>Diagnostic timing</b></p> <ul style="list-style-type: none"> <li>When powered on, reset, or accessing an intelligent function module</li> </ul>	<p>Reset the head module.</p> <p>If the same error code is displayed again, the possible cause is a hardware failure of the head module, I/O module, intelligent function module, or END cover. (Please consult your local Mitsubishi representative.)</p>
1403	<p><b>[SP. UNIT DOWN]</b></p> <ul style="list-style-type: none"> <li>No response is returned from the intelligent function module.</li> <li>An error occurred in an intelligent function module was detected.</li> <li>Any of the I/O modules (including intelligent function modules) is being disconnected or was disconnected during the operation.</li> </ul> <p>■<b>Supplementary information</b></p> <ul style="list-style-type: none"> <li>Common information: Module No. (Slot No.)</li> <li>Individual information: -</li> </ul> <p>■<b>Diagnostic timing</b></p> <ul style="list-style-type: none"> <li>Any time</li> </ul>	<p>Reset the head module.</p> <p>If the same error code is displayed again, the possible cause is a hardware failure of the head module, I/O module, intelligent function module, or END cover. (Please consult your local Mitsubishi representative.)</p>
1500	<p><b>[AC/DC DOWN]</b></p> <ul style="list-style-type: none"> <li>Momentary power failure has occurred.</li> <li>The power supply has shut off.</li> </ul> <p>■<b>Supplementary information</b></p> <ul style="list-style-type: none"> <li>Common information: -</li> <li>Individual information: -</li> </ul> <p>■<b>Diagnostic timing</b></p> <ul style="list-style-type: none"> <li>Any time</li> </ul>	<p>Check the power supply status.</p>
1610	<p><b>[FLASH ROM ERROR]</b></p> <p>The number of writes to the flash ROM has exceeded 100000. (Number of writes &gt; 100000)</p> <p>■<b>Supplementary information</b></p> <ul style="list-style-type: none"> <li>Common information: -</li> <li>Individual information: -</li> </ul> <p>■<b>Diagnostic timing</b></p> <ul style="list-style-type: none"> <li>When writing data to ROM</li> </ul>	<ul style="list-style-type: none"> <li>Replace the head module.</li> <li>In "Communication Head Setting" of PLC parameter, clear the checkbox so that data of the error history and system error history will not be held when the system is powered off or the head module is reset.</li> </ul>
1700	<p><b>[BUS TIMEOUT ERR.]</b></p> <p>An error was detected on the system bus.</p> <p>■<b>Supplementary information</b></p> <ul style="list-style-type: none"> <li>Common information: -</li> <li>Individual information: -</li> </ul> <p>■<b>Diagnostic timing</b></p> <ul style="list-style-type: none"> <li>Any time</li> </ul>	<p>Reset the head module.</p>
1710	<p><b>[UNIT BUS ERROR]</b></p> <ul style="list-style-type: none"> <li>An error was detected on the system bus.</li> <li>An error was detected in the installed module.</li> </ul> <p>■<b>Supplementary information</b></p> <ul style="list-style-type: none"> <li>Common information: -</li> <li>Individual information: -</li> </ul> <p>■<b>Diagnostic timing</b></p> <ul style="list-style-type: none"> <li>Any time</li> </ul>	<p>If the same error code is displayed again, the possible cause is a hardware failure of the head module, I/O module, intelligent function module, or END cover. (Please consult your local Mitsubishi representative.)</p>

Error code	Error and cause	Action
1720	<p><b>[END COVER ERR.]</b> An error was detected in the END cover.</p> <p>■<b>Supplementary information</b></p> <ul style="list-style-type: none"> <li>• Common information: -</li> <li>• Individual information: -</li> </ul> <p>■<b>Diagnostic timing</b></p> <ul style="list-style-type: none"> <li>• When powered on or reset</li> </ul>	<ul style="list-style-type: none"> <li>• Replace the END cover.</li> <li>• Reset the head module.</li> </ul>
1730	<p><b>[SYSTEM RST ERR.]</b> An error was detected on the system bus.</p> <p>■<b>Supplementary information</b></p> <ul style="list-style-type: none"> <li>• Common information: -</li> <li>• Individual information: -</li> </ul> <p>■<b>Diagnostic timing</b></p> <ul style="list-style-type: none"> <li>• When powered on or reset</li> </ul>	<p>If the same error code is displayed again, the possible cause is a hardware failure of the head module, intelligent function module, or END cover. (Please consult your local Mitsubishi representative.)</p>
2030	<p><b>[NO END COVER]</b> An END cover is not installed.</p> <p>■<b>Supplementary information</b></p> <ul style="list-style-type: none"> <li>• Common information: -</li> <li>• Individual information: -</li> </ul> <p>■<b>Diagnostic timing</b></p> <ul style="list-style-type: none"> <li>• When powered on or reset</li> </ul>	<ul style="list-style-type: none"> <li>• Install an END cover.</li> <li>• Check if the modules are correctly connected, referring to the configuration of the modules in the System Monitor window.</li> <li>• Reset the head module.</li> </ul>
2031	<p><b>[NO END COVER]</b> An END cover is not installed.</p> <p>■<b>Supplementary information</b></p> <ul style="list-style-type: none"> <li>• Common information: -</li> <li>• Individual information: -</li> </ul> <p>■<b>Diagnostic timing</b></p> <ul style="list-style-type: none"> <li>• Any time</li> </ul>	<p>If the same error code is displayed again, the possible cause is a hardware failure of the head module, I/O module, intelligent function module, or END cover. (Please consult your local Mitsubishi representative.)</p>
2040	<p><b>[UNIT BAD CONNECT]</b></p> <ul style="list-style-type: none"> <li>• The information is different from the I/O module information at the time of power on.</li> <li>• Any of the I/O modules (including intelligent function modules) is being disconnected or was disconnected during the operation.</li> </ul> <p>■<b>Supplementary information</b></p> <ul style="list-style-type: none"> <li>• Common information: Module No. (Slot No.)</li> <li>• Individual information: -</li> </ul> <p>■<b>Diagnostic timing</b></p> <ul style="list-style-type: none"> <li>• Any time</li> </ul>	<ul style="list-style-type: none"> <li>• Read common information on the error using the programming tool, check the module corresponding to the value (module No.), and replace the module.</li> <li>• Monitor SD1400 to SD1431 on the programming tool, check the module corresponding to the bit indicating "1", and replace the module.</li> <li>• Reset the head module.</li> </ul> <p>If the same error code is displayed again, the possible cause is a hardware failure of the head module, I/O module, intelligent function module, or END cover. (Please consult your local Mitsubishi representative.)</p>
2100	<p><b>[SP. UNIT LAY ERR.]</b></p> <ul style="list-style-type: none"> <li>• In "I/O Assignment" of PLC parameter, "Intelligent" is set for the position of an I/O module, or vice versa.</li> <li>• In "I/O Assignment" of PLC parameter, the intelligent function module switch setting is set for the module that does not support it.</li> <li>• In "I/O Assignment" of PLC parameter, the number of points smaller than that of the actual intelligent function module is assigned.</li> </ul> <p>■<b>Supplementary information</b></p> <ul style="list-style-type: none"> <li>• Common information: Module No. (Slot No.)</li> <li>• Individual information: -</li> </ul> <p>■<b>Diagnostic timing</b></p> <ul style="list-style-type: none"> <li>• When powered on or reset</li> </ul>	<ul style="list-style-type: none"> <li>• Correct the I/O Assignment setting of PLC parameter, according to the actual condition of the intelligent function module(s) and head module.</li> <li>• In "I/O Assignment" of PLC Parameter, delete the intelligent function module switch settings.</li> </ul>
2107	<p><b>[SP. UNIT LAY ERR.]</b> A start X/Y set in "I/O Assignment" of PLC parameter is overlapped with that of another module.</p> <p>■<b>Supplementary information</b></p> <ul style="list-style-type: none"> <li>• Common information: Module No. (Slot No.)</li> <li>• Individual information: -</li> </ul> <p>■<b>Diagnostic timing</b></p> <ul style="list-style-type: none"> <li>• When powered on or reset</li> </ul>	<p>Correct the I/O Assignment setting of PLC parameter, according to the actual condition of the intelligent function module(s) and I/O module(s).</p>

Error code	Error and cause	Action
2124	<p><b>[SP. UNIT LAY ERR.]</b></p> <ul style="list-style-type: none"> <li>The number of installed modules has exceeded 10.</li> <li>A module is installed in the position corresponding to the I/O points of 4096 or greater.</li> <li>A module is installed across the boundary of 4096 I/O points.</li> </ul> <p>■<b>Supplementary information</b></p> <ul style="list-style-type: none"> <li>Common information: -</li> <li>Individual information: -</li> </ul> <p>■<b>Diagnostic timing</b></p> <ul style="list-style-type: none"> <li>When powered on or reset</li> </ul>	<ul style="list-style-type: none"> <li>Reduce the number of installed modules to 10 or less.</li> <li>Remove the module installed in the position corresponding to the I/O points of 4096 or greater.</li> <li>Replace the end module so that the number of occupied points does not exceed 4096.</li> <li>Reset the head module.</li> </ul> <p>If the same error code is displayed again, the possible cause is a hardware failure of the head module, I/O module, intelligent function module, or END cover. (Please consult your local Mitsubishi representative.)</p>
2125	<p><b>[SP. UNIT LAY ERR.]</b></p> <ul style="list-style-type: none"> <li>An inappropriate module was installed.</li> <li>No response is returned from the intelligent function module.</li> </ul> <p>■<b>Supplementary information</b></p> <ul style="list-style-type: none"> <li>Common information: Module No. (Slot No.)</li> <li>Individual information: -</li> </ul> <p>■<b>Diagnostic timing</b></p> <ul style="list-style-type: none"> <li>When powered on or reset</li> </ul>	<ul style="list-style-type: none"> <li>Install an appropriate module.</li> <li>Reset the head module.</li> </ul> <p>If the same error code is displayed again, the possible cause is a hardware failure of the head module, I/O module, intelligent function module, or END cover. (Please consult your local Mitsubishi representative.)</p>
2170	<p><b>[SYSTEM LAY ERR.]</b></p> <p>An inappropriate module was installed.</p> <p>■<b>Supplementary information</b></p> <ul style="list-style-type: none"> <li>Common information: -</li> <li>Individual information: -</li> </ul> <p>■<b>Diagnostic timing</b></p> <p>When powered on or reset</p>	<ul style="list-style-type: none"> <li>Disconnect the inappropriate module.</li> <li>Reset the head module.</li> </ul> <p>If the same error code is displayed again, the possible cause is a hardware failure of the head module, I/O module, intelligent function module, or END cover. (Please consult your local Mitsubishi representative.)</p>
3000	<p><b>[PARAMETER ERROR]</b></p> <p>In PLC parameter, the number of points for empty slots is not set within the range allowed for the head module.</p> <p>■<b>Supplementary information</b></p> <ul style="list-style-type: none"> <li>Common information: File name/Drive name</li> <li>Individual information: Parameter No.</li> </ul> <p>■<b>Diagnostic timing</b></p> <ul style="list-style-type: none"> <li>When powered on or reset, or when writing to PLC</li> </ul>	<ul style="list-style-type: none"> <li>Read detailed error information using the programming tool, and check and correct the parameter corresponding to the value (parameter No.).</li> <li>Write the corrected parameters to the head module again, and reset or reapply power to the head module.</li> </ul> <p>If the the same error code is displayed again, the possible cause is a hardware failure of the head module. (Please consult your local Mitsubishi representative.)</p>
3001	<p><b>[PARAMETER ERROR]</b></p> <p>The parameter setting is corrupted.</p> <p>■<b>Supplementary information</b></p> <ul style="list-style-type: none"> <li>Common information: File name/Drive name</li> <li>Individual information: Parameter No.</li> </ul> <p>■<b>Diagnostic timing</b></p> <ul style="list-style-type: none"> <li>When powered on or reset, or when writing to PLC</li> </ul>	<ul style="list-style-type: none"> <li>Read detailed error information using the programming tool, and check and correct the parameter corresponding to the value (parameter No.).</li> <li>Write the corrected parameters to the head module again, and reset or reapply power to the head module.</li> </ul> <p>If the the same error code is displayed again, the possible cause is a hardware failure of the head module. (Please consult your local Mitsubishi representative.)</p>
3004	<p><b>[PARAMETER ERROR]</b></p> <p>The parameter file is incorrect. Or, the contents of the file are not parameters.</p> <p>■<b>Supplementary information</b></p> <ul style="list-style-type: none"> <li>Common information: File name/Drive name</li> <li>Individual information: Parameter No.</li> </ul> <p>■<b>Diagnostic timing</b></p> <ul style="list-style-type: none"> <li>When powered on or reset, or when writing to PLC</li> </ul>	<p>Check if the type of the parameter file is shown as "****.QPA" and if the file contains parameters.</p>
3105	<p><b>[LINK PARA. ERROR]</b></p> <ul style="list-style-type: none"> <li>Although the number of modules is set to 1 or more in network parameter for CC-Link, the number of actually connected modules is 0.</li> <li>The start I/O number set in the parameter setting is different from the actual I/O number.</li> <li>In the network parameter setting for CC-Link, any of the station types is mismatched.</li> </ul> <p>■<b>Supplementary information</b></p> <ul style="list-style-type: none"> <li>Common information: File name/Drive name</li> <li>Individual information: Parameter No.</li> </ul> <p>■<b>Diagnostic timing</b></p> <ul style="list-style-type: none"> <li>When powered on or reset</li> </ul>	<p>Correct the network parameter settings, and then write them.</p> <p>If the error occurs again even after the correction, the module may have failed. (Please consult your local Mitsubishi representative.)</p>

Error code	Error and cause	Action
3106	<p><b>[LINK PARA. ERROR]</b> A network refresh parameter for CC-Link is out of range.</p> <p>■<b>Supplementary information</b></p> <ul style="list-style-type: none"> <li>• Common information: File name/Drive name</li> <li>• Individual information: Parameter No.</li> </ul> <p>■<b>Diagnostic timing</b></p> <ul style="list-style-type: none"> <li>• When powered on or reset</li> </ul>	<p>Correct the network parameter settings, and then write them.</p> <p>If the error occurs again even after the correction, the module may have failed. (Please consult your local Mitsubishi representative.)</p>
3107	<p><b>[LINK PARA. ERROR]</b></p> <ul style="list-style-type: none"> <li>• The CC-Link parameter setting is incorrect.</li> <li>• The mode not available for the installed CC-Link module version is set.</li> </ul> <p>■<b>Supplementary information</b></p> <ul style="list-style-type: none"> <li>• Common information: File name/Drive name</li> <li>• Individual information: Parameter No.</li> </ul> <p>■<b>Diagnostic timing</b></p> <ul style="list-style-type: none"> <li>• When powered on or reset</li> </ul>	<p>Correct the parameter setting.</p>
3300	<p><b>[SP. PARA ERROR]</b> The start I/O number for the intelligent function module set in GX Works2 is different from the actual one.</p> <p>■<b>Supplementary information</b></p> <ul style="list-style-type: none"> <li>• Common information: File name/Drive name</li> <li>• Individual information: Parameter No.</li> </ul> <p>■<b>Diagnostic timing</b></p> <ul style="list-style-type: none"> <li>• When powered on or reset, or when writing to PLC</li> </ul>	<p>Correct the parameter setting.</p>
3301	<p><b>[SP. PARA ERROR]</b></p> <ul style="list-style-type: none"> <li>• Auto refresh parameters for the intelligent function module are out of range.</li> <li>• The intelligent function module set in GX Works2 is different from the actually installed module.</li> </ul> <p>■<b>Supplementary information</b></p> <ul style="list-style-type: none"> <li>• Common information: File name/Drive name</li> <li>• Individual information: Parameter No.</li> </ul> <p>■<b>Diagnostic timing</b></p> <ul style="list-style-type: none"> <li>• When powered on or reset, or when writing to PLC</li> </ul>	<p>Correct the parameter setting.</p>
3302	<p><b>[SP. PARA ERROR]</b> Intelligent function module parameters are incorrect.</p> <p>■<b>Supplementary information</b></p> <ul style="list-style-type: none"> <li>• Common information: File name/Drive name</li> <li>• Individual information: Parameter No.</li> </ul> <p>■<b>Diagnostic timing</b></p> <ul style="list-style-type: none"> <li>• When powered on or reset, or when writing to PLC</li> </ul>	<p>Correct the parameter setting.</p>
3400	<p><b>[REMOTE PASS. ERR.]</b> The start I/O number of the remote password target module is set to any other than 0000H to 0FF0H.</p> <p>■<b>Supplementary information</b></p> <ul style="list-style-type: none"> <li>• Common information: -</li> <li>• Individual information: -</li> </ul> <p>■<b>Diagnostic timing</b></p> <ul style="list-style-type: none"> <li>• When powered on or reset</li> </ul>	<p>Change the start I/O number of the target module to a number within the range of 0000H to 0FF0H.</p>
3401	<p><b>[REMOTE PASS. ERR.]</b> The position specified with the start I/O number in the remote password setting is abnormal.</p> <ul style="list-style-type: none"> <li>• No module is installed at the position.</li> <li>• An intelligent function module other than the serial communication module is installed at the position.</li> </ul> <p>■<b>Supplementary information</b></p> <ul style="list-style-type: none"> <li>• Common information: -</li> <li>• Individual information: -</li> </ul> <p>■<b>Diagnostic timing</b></p> <ul style="list-style-type: none"> <li>• When powered on or reset</li> </ul>	<p>Install an intelligent function module that supports the remote password function in the position specified with the I/O number in the remote password setting.</p>

Error code	Error and cause	Action
5000  5001	<p><b>[WDT ERROR]</b></p> <ul style="list-style-type: none"> <li>• I/O refresh processing time exceeded 200ms. Momentary power failure occurs frequently.</li> </ul> <p>■ <b>Supplementary information</b></p> <ul style="list-style-type: none"> <li>• Common information: Time (200ms)</li> <li>• Individual information: Time (value actually measured)</li> </ul> <p>■ <b>Diagnostic timing</b></p> <ul style="list-style-type: none"> <li>• Any time</li> </ul>	<p>Modify the power supply system to prevent momentary power failure.</p>
9900	<p><b>[NETWORK ERROR]</b></p> <p>A CC-Link IE Field Network error has occurred.</p> <p>■ <b>Supplementary information</b></p> <ul style="list-style-type: none"> <li>• Common information: -</li> <li>• Individual information: -</li> </ul> <p>■ <b>Diagnostic timing</b></p> <ul style="list-style-type: none"> <li>• Any time</li> </ul>	<ul style="list-style-type: none"> <li>• Check the details of the error by executing the CC-Link IE Field Network diagnostics, and take action.</li> <li>• In the system error history on the "System Monitor" window, check the error code of the network error detected at the time.</li> </ul>



## (2) Error codes (4000H to 4FFFH)

If an error occurs at communication request from the programming tool, intelligent function module, or network system connected, the head module returns the error code (any of 4000H to 4FFFH) to the request source. This error code is not stored in SD0 because the error is not the one detected by the self-diagnostic function of the head module.

When the request source is a programming tool, a message and an error code are displayed on the programming tool. When the request source is an intelligent function module or network system, the head module returns an error code to the request source.

For messages, details, causes, and actions of errors, refer to the following.

 User's Manual (Hardware Design, Maintenance and Inspection) for the CPU module used

## (3) Error codes (D000H to DFFFH)

The following table lists the error messages, error conditions, causes, and actions of the error codes (D000H to DFFFH).

Error code	Error	Action
D0A0H	Transient data transmission response wait timeout	<ul style="list-style-type: none"> <li>• If the own station or target station is disconnected from the network, identify the cause of the disconnection and take action.</li> <li>• When the mode of the master station is "Online (High Speed Mode)", change it to "Online (Normal Mode)" and retry the operation.</li> <li>• When the receiving station encountered overloading of transient data, reduce the frequency of transient transmission and then retry the operation.</li> </ul>
D0A1H	Transient data transmission completion wait timeout	<ul style="list-style-type: none"> <li>• Check if the cables and the switching hub are connected properly.</li> <li>• Connect the cable to the other port on the module, and retry the operation.</li> <li>• Reduce the frequency of transient transmission, and retry the operation.</li> <li>• Execute a unit test for the head module. If a failure occurs again, the possible cause is a hardware failure of the head module. Please consult your local Mitsubishi representative.</li> </ul>
D0A2H	Transient data transmission processing wait timeout	<ul style="list-style-type: none"> <li>• Reduce the frequency of transient transmission, and retry the operation.</li> <li>• Check if the switching hub and the cables at the request source are connected properly.</li> </ul>
D0A3H	Transient data transmission error	<ul style="list-style-type: none"> <li>• If the own station or target station is disconnected from the network, identify the cause of the disconnection and take action.</li> <li>• Correct the target station number of transient data, and retry the operation.</li> <li>• If the station for which transient data is to be sent is on another network, check if the routing parameters for each station are correctly set.</li> </ul>
D0A4H to D0A6H	Transient transmission failed	<ul style="list-style-type: none"> <li>• Check if the cables and the switching hub are connected properly.</li> <li>• Connect the cable to the other port on the module, and retry the operation.</li> <li>• Reduce the frequency of transient transmission, and retry the operation.</li> <li>• Execute a unit test for the head module. If a failure occurs again, the possible cause is a hardware failure of the head module. Please consult your local Mitsubishi representative.</li> </ul>
D0A7H	Transient reception failed	<ul style="list-style-type: none"> <li>• Check if the cables and the switching hub are connected properly.</li> <li>• Connect the cable to the other port on the module, and retry the operation.</li> <li>• Reduce the frequency of transient transmission, and retry the operation.</li> <li>• Execute a unit test for the head module. If a failure occurs again, the possible cause is a hardware failure of the head module. Please consult your local Mitsubishi representative.</li> </ul>
D0E0H	Station type mismatch	In the network configuration settings of the master station, change the station type of the head module to "Intelligent Device Station".

Error code	Error	Action
D0E1H	Own station reserved	<ul style="list-style-type: none"> <li>• In the network configuration settings of the master station, cancel the reserved station setting.</li> <li>• Change the station number of the head module to a station number that is not reserved.</li> </ul>
D0E2H	Station No. already in use (own station)	<ul style="list-style-type: none"> <li>• Set a unique station number.</li> <li>• After taking the above action, power off and on all the stations where this error has been detected or reset them.</li> </ul>
D0E3H	Own station No. out of range	Add the station information of the head module in the network configuration settings of the master station.
D200H	Transient data received twice	<ul style="list-style-type: none"> <li>• Check the network status by executing the CC-Link IE Field Network diagnostics using the programming tool, and take action.</li> <li>• Check if the cables and the switching hub are connected properly.</li> <li>• If the request source is on another network, check if the routing parameters are correctly set.</li> </ul>
D201H	Header information error in transient transmission	Correct the header information at the request source, and retry the operation.
D202H	Send buffer full	<ul style="list-style-type: none"> <li>• Reduce the frequency of transient transmission, and retry the operation.</li> <li>• When the mode of the master station is "Online (High Speed Mode)", change it to "Online (Normal Mode)" and retry the operation.</li> <li>• Check if the cables and the switching hub are connected properly.</li> </ul>
D203H	Read/write address error in transient transmission	Correct the read/write address at the request source, and retry the operation.
D204H	Network No. error in transient transmission	<ul style="list-style-type: none"> <li>• Check the network number at the request source, and retry the operation.</li> <li>• If the request source is on another network, check if the routing parameters are correctly set.</li> </ul>
D205H	Target station No. error in transient transmission	Correct the target station number at the request source, and retry the operation.
D206H	Network No. error in transient transmission	<ul style="list-style-type: none"> <li>• Check the network number at the request source, and retry the operation.</li> <li>• If the request source is on another network, check if the routing parameters are correctly set.</li> </ul>
D207H	Invalid number of relays in transient transmission	<ul style="list-style-type: none"> <li>• Change the system configuration so that the number of relay stations may be seven or less.</li> <li>• Check if the routing parameters are correctly set.</li> </ul>
D208H	Network No. error in transient transmission	<ul style="list-style-type: none"> <li>• Check the network number at the request source, and retry the operation.</li> <li>• If the request source is on another network, check if the routing parameters are correctly set.</li> </ul>
D209H and D20AH	Target station No. error in transient transmission	Check the target station number at the request source, and retry the operation.
D20BH	Specified master station No. error in transient transmission	
D20CH	Current master station No. error in transient transmission	
D20DH	Transient data transmission completion wait timeout	<ul style="list-style-type: none"> <li>• Check the network status by executing the CC-Link IE Field Network diagnostics using the programming tool, and take action.</li> <li>• When the own station or target station detected an error, identify the cause of the error and take action.</li> <li>• Reduce the frequency of transient transmission, and retry the operation.</li> <li>• When the mode of the master station is "Online (High Speed Mode)", change it to "Online (Normal Mode)" and retry the operation.</li> <li>• Check if the switching hub and the cables at the request source are connected properly.</li> </ul>
D20EH	Header information error in transient transmission	Correct the header information at the request source, and retry the operation.

Error code	Error	Action
D20FH	Target station No. error in transient transmission	Check that the command can be requested to all or a group of stations at the request source, and retry the operation.
D210H	Target station No. error in transient transmission	Correct the header information at the request source, and retry the operation.
D211H	Own station No. not set (dedicated instruction)	Set the station number in the parameter setting, and retry the operation.
D212H	Transient transmission failed	<ul style="list-style-type: none"> <li>• Check if the switching hub and the cables at the request source are connected properly.</li> <li>• Connect the cable to the other port on the module, and retry the operation.</li> <li>• Reduce the frequency of transient transmission, and retry the operation.</li> </ul>
D213H	Transient data command error	<ul style="list-style-type: none"> <li>• Correct the request command at the request source, and retry the operation.</li> <li>• Check the serial number (first five digits) of the master/local module. If the master/local module does not support the function, replace it with the master/local module with the latest version.</li> </ul>
D214H	Transient data length error	Correct the data length at the request source, and retry the operation.
D216H and D217H	Transient data command error	Correct the request command at the request source, and retry the operation.
D218H	Incorrect number of read/write transient data	Correct the number of read/write device data at the request source, and retry the operation.
D219H	Transient data attribute code error	Correct the attribute code at the request source, and retry the operation.
D21AH	Transient data access code error	Correct the access code at the request source, and retry the operation.
D21BH and D21CH	Head module request error	<ul style="list-style-type: none"> <li>• A malfunction may have occurred due to noise. Check the wire and cable distances and grounding condition of each device, and take measures to reduce noise.</li> <li>• Execute a unit test for the head module. If a failure occurs again, the possible cause is a hardware failure of the head module. Please consult your local Mitsubishi representative.</li> </ul>
D21DH	Network No. error in transient transmission	<ul style="list-style-type: none"> <li>• A cable test cannot be executed for a different network. Correct "Testing Station Setting", and execute the cable test again.</li> <li>• Transient data that cannot be sent to a different network were received. Correct the network number or the target station number at the request source, and retry the operation.</li> </ul>
D21EH	Target station No. error in transient transmission	<ul style="list-style-type: none"> <li>• A communication test cannot be executed on a relay sending station. Correct "Target Station" setting, and execute the communication test again.</li> <li>• Transient data of the application type that cannot be executed on the own station were received. Correct the application type or the target station number at the request source, and retry the operation.</li> </ul>
D21FH	Target station type error (dedicated instruction)	The SEND instruction cannot be executed on the head module. Modify the program of the master and local stations so that the SEND instruction may not be executed.
D222H	Transient data command error	Correct the request command at the request source, and retry the operation.
D247H	Dedicated instruction received twice	<ul style="list-style-type: none"> <li>• Check the network status by executing the CC-Link IE Field Network diagnostics using the programming tool, and take action.</li> <li>• Check if the switching hub and the cables at the request source are connected properly.</li> <li>• If the request source is on another network, check if the routing parameters are correctly set.</li> </ul>
D280H	Transient data request error	Correct the request command at the request source, and retry the operation.

Error code	Error	Action
D281H	Transient reception failed	<ul style="list-style-type: none"> <li>• Check the network status by executing the CC-Link IE Field Network diagnostics using the programming tool, and take action.</li> <li>• When the target station is overloaded and cannot receive transient data, send the data to the target/relay station after the load on the station is reduced.</li> </ul>
D282H	Receive queue full	<ul style="list-style-type: none"> <li>• Check the network status by executing the CC-Link IE Field Network diagnostics using the programming tool, and take action.</li> <li>• When the target station is overloaded and cannot receive transient data, send the data to the target/relay station after the load on the station is reduced.</li> </ul>
D283H	Transient transmission failed	<ul style="list-style-type: none"> <li>• Check the network status by executing the CC-Link IE Field Network diagnostics using the programming tool, and take action.</li> <li>• Connect the cable to the other port on the request source, and retry the operation.</li> <li>• Reduce the frequency of transient transmission, and retry the operation.</li> </ul>
D2A0H	Receive buffer full	<ul style="list-style-type: none"> <li>• Check the network status by executing the CC-Link IE Field Network diagnostics using the programming tool, and take action.</li> <li>• When the target station is overloaded and cannot receive transient data, send the data to the target/relay station after the load on the station is reduced.</li> </ul>
D2A1H	Send buffer full	<ul style="list-style-type: none"> <li>• Reduce the frequency of transient transmission, and retry the operation.</li> <li>• Check if the switching hub and the cables at the request source are connected properly.</li> </ul>
D2A2H	Transmission completion wait timer timeout	<ul style="list-style-type: none"> <li>• Reduce the frequency of transient transmission, and retry the operation.</li> <li>• When the mode of the master station is "Online (High Speed Mode)", change it to "Online (Normal Mode)" and retry the operation.</li> <li>• Check if the switching hub and the cables at the request source are connected properly.</li> <li>• Correct the number of link dedicated instructions that have been simultaneously executed within the range. (For details, refer to "Precautions for link dedicated instructions" in the user's manual for the master/local module used.)</li> </ul>
D2A3H	Transient data length error	Correct the number of data (frame length) at the request source, and retry the operation.
D2A4H	Header information error in transient transmission	Correct the header information at the request source, and retry the operation.
D2A5H	Target station No. error in transient transmission	Correct the target station number at the request source, and retry the operation.
D2A6H	Transient data request source No. error	Correct the request source number at the request source, and retry the operation.
D2A7H and D2A8H	Header information error in transient transmission	Correct the header information at the request source, and retry the operation.
D2A9H	Target network No. error in transient transmission	Correct the target network number at the request source, and retry the operation.
D2AAH	Target station No. error in transient transmission	Correct the target station number at the request source, and retry the operation.
D2ABH	Request source network No. error in transient transmission	Correct the network number of the request source at the request source, and retry the operation.
D2ACH	Transient data request source No. error	Correct the station number of the request source at the request source, and retry the operation.
D2ADH	Transient data length error	Correct the number of data (frame length) at the request source, and retry the operation.

Error code	Error	Action
D2AEH	Target station No. error in transient transmission	<ul style="list-style-type: none"> <li>The head module received transient data addressed to a different network. Check the network number and target station number, and retry the operation.</li> <li>Check if the routing parameters are correctly set.</li> </ul>
D2AFH	Target station No. error in transient transmission	<ul style="list-style-type: none"> <li>Transient data transmission addressed to the own station was requested. Check the network number and target station number, and retry the operation.</li> <li>Check if the routing parameters are correctly set.</li> </ul>
D2B0H	Transient transmission failed	<ul style="list-style-type: none"> <li>Check if the switching hub and the cables at the request source are connected properly.</li> <li>Connect the cable to the other port on the request source, and retry the operation.</li> <li>Reduce the frequency of transient transmission, and retry the operation.</li> </ul>
D501H	Communication LSI failure	<ul style="list-style-type: none"> <li>A malfunction may have occurred due to noise. Check the wire and cable distances and grounding condition of each device, and take measures to reduce noise.</li> <li>Execute a unit test for the head module. If a failure occurs again, the possible cause is a hardware failure of the head module. Please consult your local Mitsubishi representative.</li> </ul>
D502H	MAC address error	<ul style="list-style-type: none"> <li>A malfunction may have occurred due to noise. Check the wire and cable distances and grounding condition of each device, and take measures to reduce noise.</li> <li>Execute a unit test for the head module. If a failure occurs again, the possible cause is a hardware failure of the head module. Please consult your local Mitsubishi representative.</li> </ul>
D529H and D52AH	RAM failure	<ul style="list-style-type: none"> <li>A malfunction may have occurred due to noise. Check the wire and cable distances and grounding condition of each device, and take measures to reduce noise.</li> <li>Execute a unit test for the head module. If a failure occurs again, the possible cause is a hardware failure of the head module. Please consult your local Mitsubishi representative.</li> </ul>
D52BH and D52CH	Communication LSI failure	<ul style="list-style-type: none"> <li>A malfunction may have occurred due to noise. Check the wire and cable distances and grounding condition of each device, and take measures to reduce noise.</li> <li>Execute a unit test for the head module. If a failure occurs again, the possible cause is a hardware failure of the head module. Please consult your local Mitsubishi representative.</li> </ul>
D62DH	Data link start failed	<p>Data link start failed due to any of the following causes. Eliminate the error cause, and retry the operation.</p> <ul style="list-style-type: none"> <li>Station number not set</li> <li>Head module error</li> <li>More than one master station</li> <li>Station type mismatch</li> <li>Master station lost</li> <li>Own station No. out of range</li> <li>Station No. already in use (own station)</li> <li>Own station reserved</li> <li>Parameter error</li> <li>Parameter communication in progress</li> <li>Parameters not received (master station only and no slave station exists)</li> <li>Link stop command</li> </ul>
D62EH	Master station lost	<p>Communications cannot be performed with the master station. Check whether the cables are connected properly.</p>

Error code	Error	Action
D721H	Data link start/stop retry error (to another station)	<ul style="list-style-type: none"> <li>Data link cannot be stopped because cyclic transmission has been stopped.</li> <li>Data link cannot be started because cyclic transmission is in execution.</li> </ul>
D722H	Data link start/stop retry error (to own station)	<ul style="list-style-type: none"> <li>Data link cannot be stopped because cyclic transmission has been stopped.</li> <li>Data link cannot be started because cyclic transmission is in execution.</li> </ul>
D725H	Station type error (station that starts/stops data link throughout the entire system)	The head module cannot start or stop data link of all or multiple stations. Perform these operations from the master station.
D726H	Transient data request command error	Correct the request command at the request station, and retry the operation.
D727H	Data link start/stop command instructing stations different	<ul style="list-style-type: none"> <li>Data link start was instructed from a station different from the one that had instructed the data link stop. Instruct data link start and data link stop from the same station.</li> <li>The method of the data link start differs from that of the data link stop. Instruct the data link start using the same method as the data link stop (ex. Data link is stopped using the CC-Link IE Field Network diagnostics, and the data link is started using a program).</li> <li>Data link start has failed. Forcibly restart the data link.</li> </ul>
D728H	Data link start/stop command instructing stations different	Data link start was instructed during execution of data link. Instruct data link stop then data link start.
D729H	Station No. or network No. not set	<ul style="list-style-type: none"> <li>Set the station number or network number in the programming tool, and write the parameters.</li> <li>By online operation of the master station, set the network number or station number of the head module.</li> </ul>
D72AH	Station No. out of range	By online operation of the master station, set the network number or station number of the head module within the specified range. Network number: 1 to 239 Station number: 1 to 120
D783H and D784H	Transient data request error	<ul style="list-style-type: none"> <li>The read request by the CC-Link IE Field Network diagnostics of the programming tool is incorrect. Close the "CC IE Field Diagnostics" window, and request it again.</li> <li>Check the read request data at the request station, and retry the operation.</li> </ul>
D800H	Head module error	<ul style="list-style-type: none"> <li>A malfunction may have occurred due to noise. Check the wire and cable distances and grounding condition of each device, and take measures to reduce noise.</li> <li>Execute a unit test for the head module. If a failure occurs again, the possible cause is a hardware failure of the head module. Please consult your local Mitsubishi representative.</li> </ul>
D806H	Receive queue full	<ul style="list-style-type: none"> <li>Reduce the frequency of transient transmission, and retry the operation.</li> <li>Check if the cables and the switching hub are connected properly.</li> </ul>
D814H	Head module error	<ul style="list-style-type: none"> <li>A malfunction may have occurred due to noise. Check the wire and cable distances and grounding condition of each device, and take measures to reduce noise.</li> <li>Execute a unit test for the head module. If a failure occurs again, the possible cause is a hardware failure of the head module. Please consult your local Mitsubishi representative.</li> </ul>
D816H	Head module error	<ul style="list-style-type: none"> <li>A malfunction may have occurred due to noise. Check the wire and cable distances and grounding condition of each device, and take measures to reduce noise.</li> <li>Execute a unit test for the head module. If a failure occurs again, the possible cause is a hardware failure of the head module. Please consult your local Mitsubishi representative.</li> </ul>
D81AH	Head module stop error	Check the error in the "PLC Diagnostics" window of the programming tool, and take action.

Error code	Error	Action
D827H	Communication RAM error	<ul style="list-style-type: none"> <li>• A malfunction may have occurred due to noise. Check the wire and cable distances and grounding condition of each device, and take measures to reduce noise.</li> <li>• Execute a unit test for the head module. If a failure occurs again, the possible cause is a hardware failure of the head module. Please consult your local Mitsubishi representative.</li> </ul>
D902H	Incorrect online test data	<ul style="list-style-type: none"> <li>• Check the data at the station that started the online test, and retry the operation.</li> <li>• If the error occurs again even after taking the above, please consult your local Mitsubishi representative.</li> </ul>
D903H	Communication test retry error	After completion of the communication test, retry the operation.
D905H	Communication monitoring timeout in communication test	<ul style="list-style-type: none"> <li>• Check the network status by executing the CC-Link IE Field Network diagnostics using the programming tool, take action, and retry the operation.</li> <li>• Check if the routing parameters are correctly set.</li> </ul>
D906H	Communication test transmission completion wait timeout	<ul style="list-style-type: none"> <li>• Check the network status by executing the CC-Link IE Field Network diagnostics using the programming tool, take action, and retry the operation.</li> <li>• Reduce the frequency of transient transmission, and retry the operation.</li> <li>• When the mode of the master station is "Online (High Speed Mode)", change it to "Online (Normal Mode)" and retry the operation.</li> <li>• Check if the routing parameters are correctly set.</li> </ul>
D909H	Header information error in transient transmission	Correct the header information at the request source, and retry the operation.
D90AH	Communication test data received twice	After completion of the communication test, retry the operation.
D90BH	Incorrect number of stations	<ul style="list-style-type: none"> <li>• Check the network status by executing the CC-Link IE Field Network diagnostics using the programming tool, and take action.</li> <li>• If the number of slave stations per network is more than 120, reduce it to 120 or less.</li> </ul>
D90CH	Invalid communication test target station	Check the "Target Station" setting in the "Communication Test" window, and retry the operation.
D90DH	Cable test retry error	After completion of the cable test, retry the operation.
DA00H and DA01H	Head module error	<ul style="list-style-type: none"> <li>• A malfunction may have occurred due to noise. Check the wire and cable distances and grounding condition of each device, and take measures to reduce noise.</li> <li>• Execute a unit test for the head module. If a failure occurs again, the possible cause is a hardware failure of the head module. Please consult your local Mitsubishi representative.</li> </ul>
DA10H to DA18H	Head module error	<ul style="list-style-type: none"> <li>• A malfunction may have occurred due to noise. Check the wire and cable distances and grounding condition of each device, and take measures to reduce noise.</li> <li>• Execute a unit test for the head module. If a failure occurs again, the possible cause is a hardware failure of the head module. Please consult your local Mitsubishi representative.</li> </ul>
DAF2H	Flash ROM error	<ul style="list-style-type: none"> <li>• If the number of writes to the flash ROM has exceeded 100000, clear the checkbox in "Communication Head Setting" of PLC parameter so that data of the error history and system error history will not be held when the system is powered off or the head module is reset.</li> <li>• Check the wire and cable distances and grounding condition of each device, and take measures to reduce noise.</li> <li>• Execute a unit test for the head module. If a failure occurs again, the possible cause is a hardware failure of the head module. Please consult your local Mitsubishi representative.</li> </ul>

Error code	Error	Action
DAF3H	Flash ROM error	<ul style="list-style-type: none"> <li>• A malfunction may have occurred due to noise. Check the wire and cable distances and grounding condition of each device, and take measures to reduce noise.</li> <li>• Execute a unit test for the head module. If a failure occurs again, the possible cause is a hardware failure of the head module. Please consult your local Mitsubishi representative.</li> </ul>



# APPENDICES

## Appendix 1 External Input/Output Forced On/Off

This function forcibly turns on or off the external input/output of the head module.

### (1) Input/output operation when a forced on/off operation is performed

Three types of forced on/off operations are available as shown in the following table. The following table shows the status of input (X) and output (Y) when a forced on/off operation is performed.

Operation	Input (X) operation	Output (Y) operation
Forced on registration	The remote input (RX) assigned to the input (X) is transmitted cyclically in a forced on-status.	Regardless of the remote output (RY) that was transmitted cyclically, "on" is output externally.
Forced off registration	The remote input (RX) assigned to the input (X) is transmitted cyclically in a forced off-status.	Regardless of the remote output (RY) that was transmitted cyclically, "off" is output externally.
Forced on/off clear	The remote input (RX) is changed by an external input.	The remote output (RY) of the master station is output to the external device.

 The following shows the input/output operation when a forced on/off operation is performed.

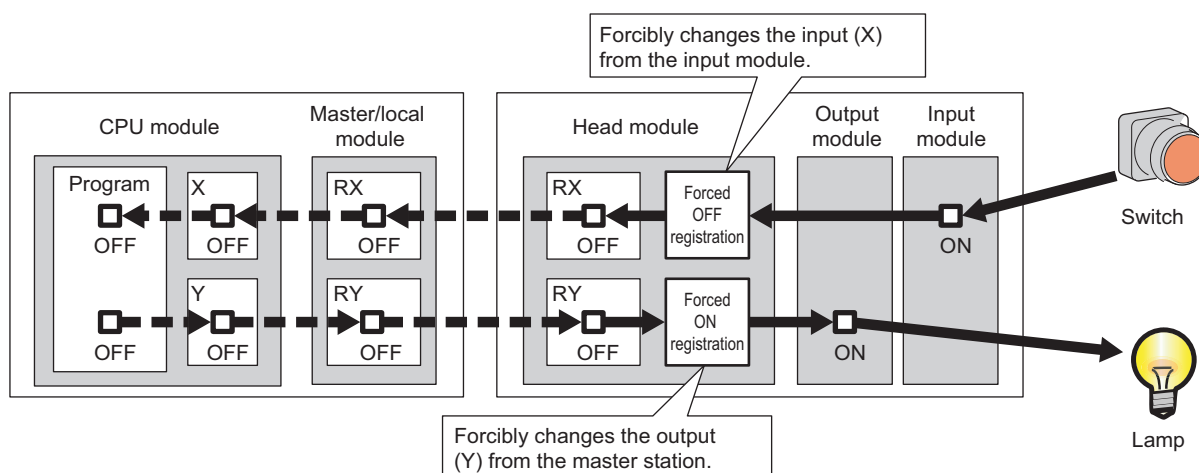

**(a) Number of devices that can be registered**

Up to 32 devices in total can be registered.

**(b) Checking the execution status**

- "Forced Input Output Registration/Cancellation" window of GX Works2
- Flashing of the MODE LED (green) (The MODE LED flashes in green when a device is registered.)
- The on status of the 0 bit in Debug function usage (SD840)

**(c) Forcibly turning on/off from multiple GX Works2**

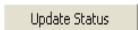
Forced on/off can be registered from multiple GX Works2 to a single head module. In this case, the last registration is effective. For this reason, the GX Works2 that executed the forced on/off may display an on/off information that is different from that of the head module. When the forced on/off registration is performed from multiple GX Works2, click the  button to update the data, and then execute the function.

**(d) Status of devices after forced on/off registration data are canceled**

When the on/off registration information of the following input (X) and output (Y) are canceled, the forced on/off status is retained.

- Of the inputs (X) in the range of unattached modules, input (X) that is outside the refresh range with CC-Link
- Output (Y) that is outside the range that was set in "RX/RX Setting" of Network Configuration Setting of the master station

**(e) Status of the head module**

The REM. LED of the head module flashes.

Forced on/off can be registered regardless of the operating status (RUN/STOP).

If an error occurs in the head module, output (Y) cannot be turned on.

**(f) Target input/output**

- Input/output (X/Y) of the connected modules
- Input/output (X/Y) of the head module that corresponds to the refresh range of the remote input/output (RX/RX) of the connected CC-Link master/local module

**(2) Operating procedure**

- 1. Open the "Forced Input Output Registration/Cancellation" window.**



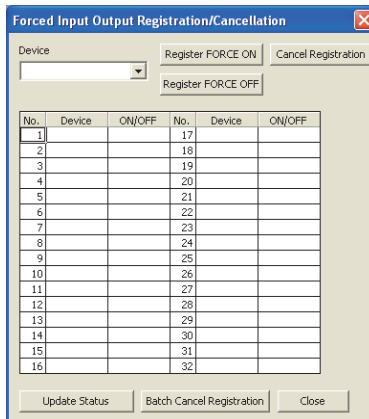

 [Debug] ⇒ [Forced Input Output Registration/Cancellation]

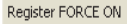

- 2. Enter the target device to the "Device" column.**

The setting range in the "Device" column is X0 to X1FFF or Y0 to Y1FFF.

- 3. Click the button for the intended operation.**

Button name	Description	Button name	Description
	Registers forced on for a specified device.		Cancels forced on/off registered for the device specified.
	Registers forced off for a specified device.		Cancels all forced on/off registrations.

The latest on/off status can be checked by clicking the  button.

# Appendix 2 File Password 32

This function sets write password and read password for each file stored in the head module. Files can be protected against tampering and theft by unauthorized persons.

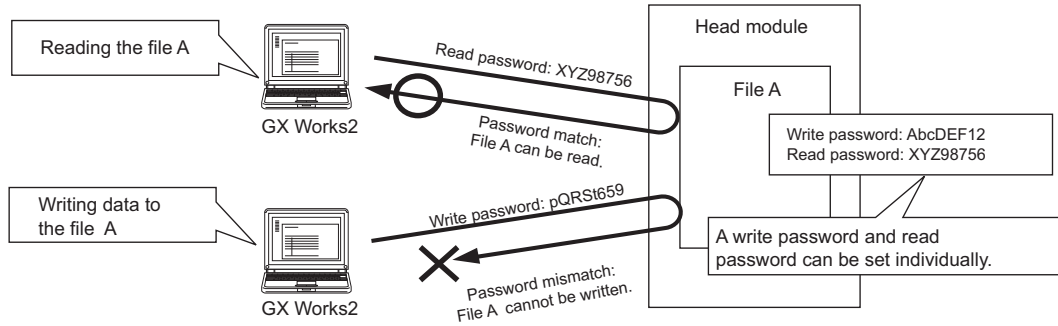

## Appendix 2.1 Setting file passwords

This section describes the characters which can be used for the password, and the types of files that can be password-protected.

### **Point**

If you forget the password, initialize the head module by executing the format PLC memory function using GX Works2, and write the project to the head module again.

### (1) Applicable characters

A read password and write password can be set individually. Alternatively, one same password can be specified for both read and write passwords.

- Applicable characters: ASCII characters (numbers, alphabets<sup>\*1</sup>, special characters<sup>\*2</sup>)
- Number of characters: 4 to 32 characters

\*1 Alphabets are case-sensitive.

\*2 Special characters are ` ~ ! @ # \$ % ^ & \* ( ) \_ + - = { } | \ : " ; ' < > ? , . / [ ] , and spaces.

### (2) File protection timing

File protection is enabled immediately after the password is registered, and it is disabled immediately after the password is deleted.

### (3) Files that can be password-protected

Passwords can be set to parameter files.

### (4) Online operations that require password authentication

Password authentication is required for the following operations whenever the file is password-protected.

 Page 119, Appendix 2.2)

- |                                  |   |
|----------------------------------|---|
| • Read from PLC (data reading)   | • Write to PLC (data writing)                                   |
| • Verify with PLC (data reading) |   |
| • Delete PLC data (data writing) | • Create/Change/Delete of a password (data reading and writing) |

## (5) Creating, changing, deleting, and disabling a password

### (a) Creating and changing a password

Open the "Create/Change Password" window.

 [Online] ⇨ [Password/Keyword] ⇨ [New]

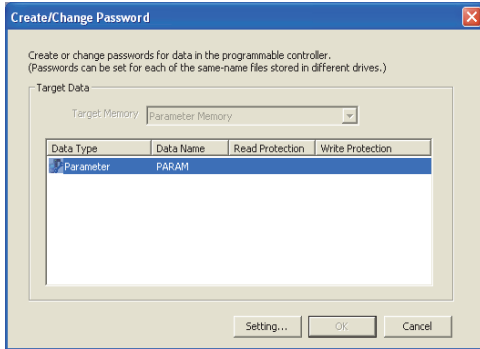

1. Click the  button.

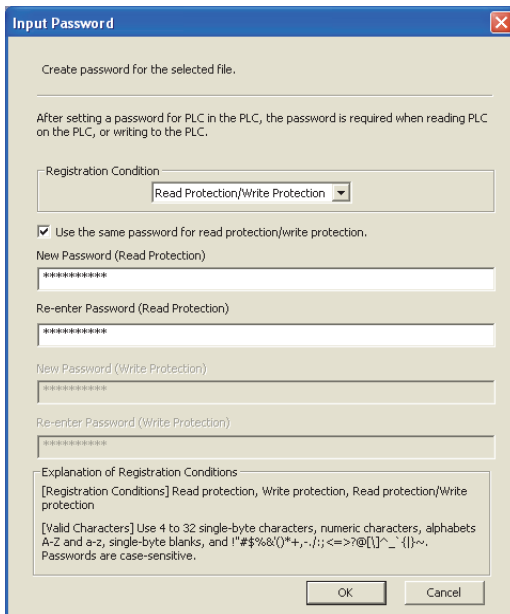

2. Select any of the following values for "Registration Condition".

- Read Protection
- Write Protection
- Read Protection/Write Protection

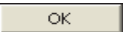
Enter a password and click the  button.

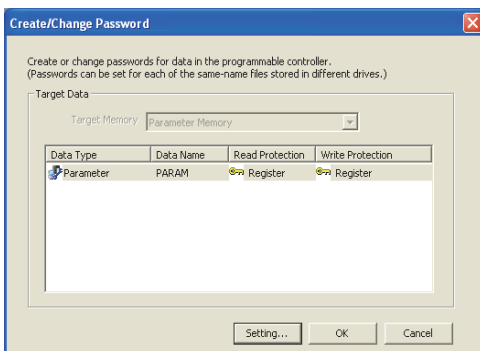

3. The registration status appears as "Register".

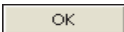
Click the  button to register the password.

**(b) Deleting a password**

Open the "Delete Password" window.

 [Online] ⇨ [Password/Keyword] ⇨ [Delete]

**1. Click the  button.**

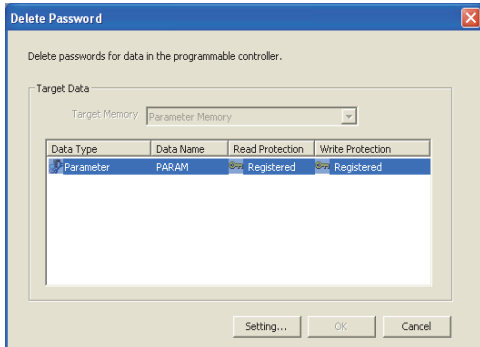

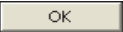
**2. Enter a password and click the  button.**

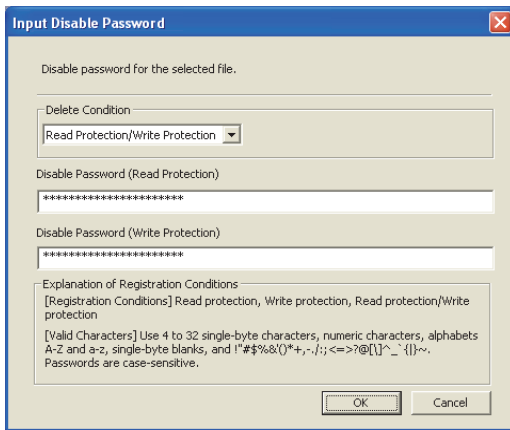

**3. The registration status appears as "Deleted".**

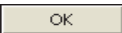
Click the  button to delete the password.

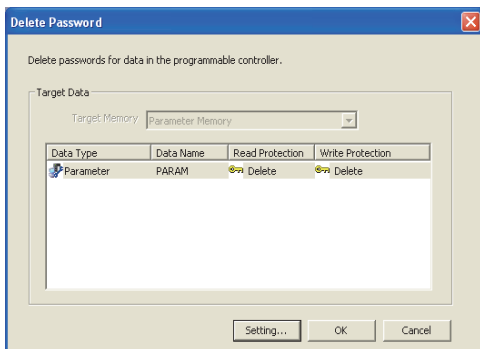

### (c) Disabling a password

Open the "Input Disable Password" window.

 [Online] ⇌ [Password/Keyword] ⇌ [Disable]

1. Click the  button.

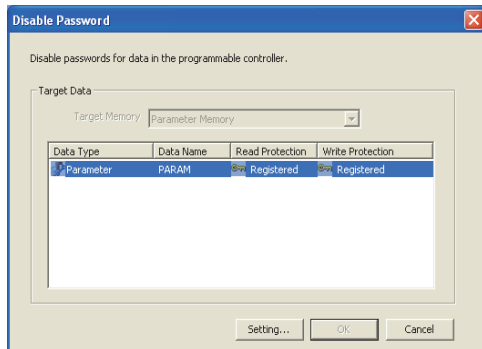

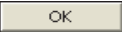
2. Enter a password and click the  button.

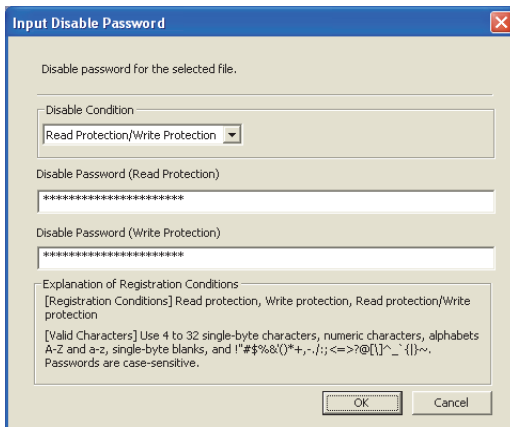

3. The registration status appears as "Disabled".

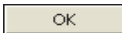
Click the  button to disable the password.

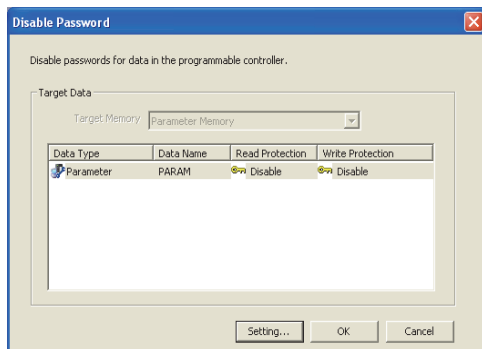



## Appendix 2.2 Password authentication method

A

The passwords are authenticated by the following methods.

- By GX Works2
- By the MC protocol

### (1) Authentication by GX Works2

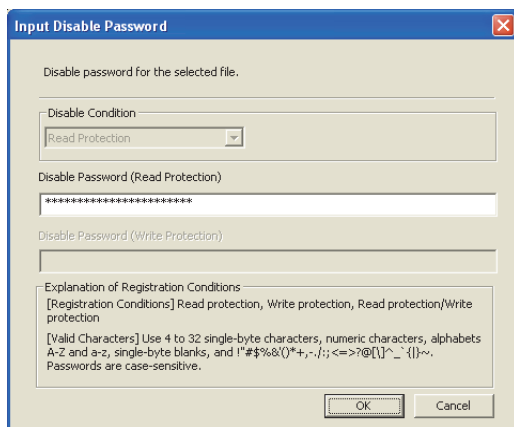
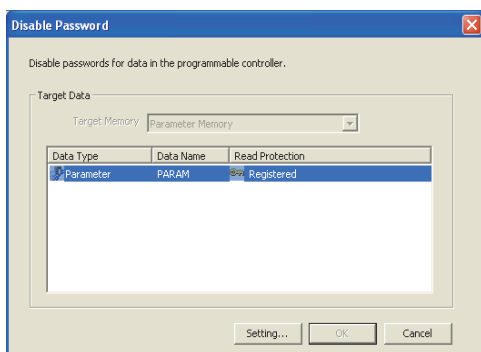

1. Whenever an online operation requiring password authentication is executed, the "Disable Password" window appears.

Click the  button.

2. Enter a password in the "Input Disable Password" window.

### Point

The entered password is valid until the project is closed.

## (2) Authentication by the MC protocol

To access a password-protected file from external devices using the MC protocol, the request message format of the MC protocol must be changed and a command for the file password 32 must be specified.

- 1. Add "Keyword" at the end of the request message, and set a password in that area.**
- 2. Authenticate the password using the password set to "Keyword".**
- 3. For the commands requiring password authentication, specify 0004 (for file password 32) in the "Subcommand" area of the request message.**

Function	Command (subcommand)
File delete	1822 (0004)
File attribute change	1825 (0004)
File copy	1824 (0004)
File open	1827 (0004)

For details, refer to the following.

 MELSEC Communication Protocol Reference Manual

# Appendix 3 END Cover

This section describes the specifications of the END cover.

For specifications of the END cover with ERR terminal (L6EC-ET), refer to the following.

 MELSEC-L CPU Module User's Manual (Hardware Design, Maintenance and Inspection)

## (1) Part names

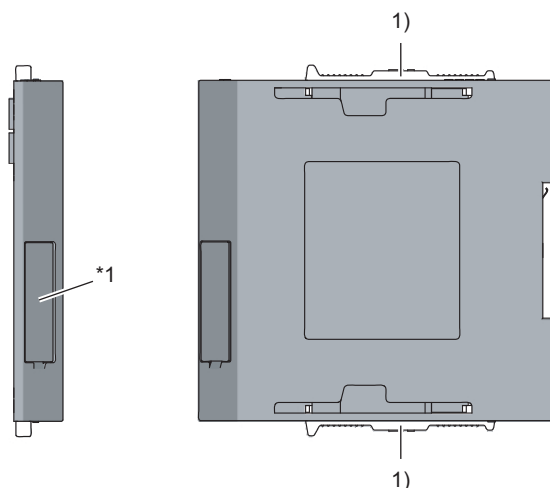

\*1 Do not remove this label as it is for maintenance.

No.	Name	Application
1)	Module joint levers	Levers for connecting modules each other

## (2) Specifications

Item		L6EC
External dimensions	H	90mm
	W	13mm
	D	95mm
Internal current consumption		0.04A
Weight		0.06kg

# Appendix 4 Link Special Relay (SB)

The link special relay (SB) is turned on/off depending on various factors during data link. An error status of the data link can be checked by monitoring it.

## (1) Application of link special relay (SB)

By using the link special relay (SB), the status of CC-Link IE Field Network can be checked from HMI (Human Machine Interfaces) as well as GX Works2.

## (2) Areas turned on/off by users and by the system

- Area turned on/off by the system: SB0000 to SB0FFF
- Area turned on/off by users: SB1000 to SB1FFF

## (3) List of link special relay (SB) areas

The following lists the link special relay (SB) areas.

### *Point*

Do not turn on or off an area whose number is not in the list. Doing so may cause malfunction of the programmable controller system.

No.	Name	Description
SB004F	Operating station number status	Stores information on whether the module is operating with the network number and station number set in the "Communication Head Setting" of PLC Parameter, or with the numbers set in the CC-Link IE Field Network diagnostics. OFF: Operating using the values set in "Communication Head Setting" of PLC Parameter ON: Operating using the values set in the CC-Link IE Field Network diagnostics  This area also turns on in the following cases: • There is no parameter in the head module. • The "Network No." and "Station No." fields are left blank in "Communication Head Setting" of PLC Parameter, and no station number has been set in the CC-Link IE Field Network diagnostics.
SB006A	PORT1 link-up status (own station)	Stores the linkup status of PORT1 (own station). OFF: Link-up ON: Link-down The time that link-up starts after power-on or Ethernet cable connection may vary. Normally link-up takes several seconds. Depending on device status on the line, the link-up processing is repeated, resulting in the increase in the time.
SB006B	PORT2 link-up status (own station)	Stores the linkup status of PORT2 (own station). OFF: Link-up ON: Link-down The time that link-up starts after power-on or Ethernet cable connection may vary. Normally link-up takes several seconds. Depending on device status on the line, the link-up processing is repeated, resulting in the increase in the time.
SB1000 to SB1FFF	For the CC-Link master/local module	By setting these areas as the refresh destination device of the link special relay (SB) of the CC-Link master/local module, the data link status of CC-Link can be checked.

# Appendix 5 Link Special Register (SW)

The link special register (SW) stores the information during data link as numerical values. Error locations and causes can be checked by monitoring the values.

## (1) Application of link special register (SW)

By using the link special register (SW), the status of CC-Link IE Field Network can be checked from HMI (Human Machine Interfaces) as well as GX Works2.

## (2) Areas to which data are stored by users and by the system

- Area to which data are stored by the system: SW0000 to SW0FFF
- Area to which data are stored by users: SW1000 to SW1FFF

## (3) List of link special register (SW) areas

The following lists the link special register (SW) areas.

### *Point*

Do not write any data to an area whose number is not on the list. Doing so may cause malfunction of the programmable controller system.

No.	Name	Description
SW0040	Network number	Stores the network number of the own station. Range: 1 to 239
SW0042	Station number	Stores the station number of the own station. Range: 1 to 120 (slave stations), FFFFH (station number not set)
SW0043	Mode status	Stores the mode of the own station. 0: Online 2: Offline 9: Unit test
SW0047	Baton pass status (own station)	Stores the communication status of the own station. 0: Data link in progress 2: Data link stopped, baton pass in progress 3: Baton pass stopped 5: Offline
SW0048	Cause of baton pass interruption	Stores the cause of interruption in the communication (baton pass) of the own station. 00H: At normal communication or power-on 30H: Cable disconnection 33H: Disconnection or return in progress 40H: Offline mode
SW0049	Cause of data link stop	Stores the cause which stopped the data link of the own station. 00H: At normal communication or power-on 01H: Stop command issued 02H: Monitoring timeout 10H: Parameter not received 11H: Station number of the own station out of the range 12H: Reserved station setting of the own station 13H: Own station number duplication 16H: Station number not set 18H: Parameter error 19H: Parameter communication in progress 1AH: Station type mismatch 20H: Error detected
SW004B	Module status (own station)	Stores the status of the head module on the own station. 01H: STOP (Normal) 02H: STOP (Stop error) 03H: STOP (Continuation error) 04H: RUN (Normal) 05H: RUN (Continuation error) 0FH: Initial processing
SW004E	Station No. set for diagnostics	Stores the network number set in the CC-Link IE Field Network diagnostics. 1 to 239: Network number FFFFH: Station number not broadcast
SW004F		Stores the station number set in the CC-Link IE Field Network diagnostics. 1 to 120: Station number FFFFH: Station number not broadcast

No.	Name	Description
SW0064	Connection status (own station)	Stores the connection status of the own station. 00H: Normal 01H: Normal (communication in progress on PORT1, cable disconnected on PORT2) 04H: Normal (loopback communication in progress on PORT1, cable disconnected on PORT2)  10H: Normal (cable disconnected on PORT1, communication in progress on PORT2) 11H: Disconnecting (cable disconnected on PORT1 and PORT2) 12H: Disconnecting (cable disconnected on PORT1, establishing line on PORT2)  21H: Disconnecting (establishing line on PORT1, cable disconnected on PORT2) 22H: Disconnecting (establishing line on PORT1 and PORT2) 40H: Normal (cable disconnected on PORT1, loopback communication in progress on PORT2)
SW1000 to SW1FFF	For the CC-Link master/local module	By setting these areas as the refresh destination device of the link special register (SW) of the CC-Link master/local module, the data link status of CC-Link can be checked.

A

## Appendix 6 Special Relay (SM)

---

The special relay (SM) is an internal relay whose application is determined in the programmable controller. However, it can be turned on/off as needed to control the head module.

The following table shows how to read the list of special relay areas.

Item	Description
No.	Special relay number
Name	Special relay name
Meaning	Contents of the special relay
Explanation	Detailed description of the special relay
Set by (Set timing)	Set side and set timing of the special relay <Set by> .S: Set by the system. .U: Set by a user (via network or by test operation from GX Works2). .S/U: Set by both the system and a user. <Set timing> The set timing is described only for the special relay areas set by the system. .Initial: During initial processing (after power-on or reset) .Status change: When the operating status is changed .Error: When an error occurs .Write: When data are written to the module

---

### **Point**

Do not change the value of any special relay areas set by the system by performing test operation. Doing so may result in system down or communication failure.

---



**(1) Diagnostic information**

No.	Name	Meaning	Explanation	Set by (Set timing)
SM0	Diagnostic error	OFF: No error ON: Error	<ul style="list-style-type: none"> <li>Turns on if an error is detected by diagnostics.</li> <li>The on state remains even after the system returns to normal.</li> </ul>	S (Error)
SM1	Self-diagnostic error	OFF: No error ON: Error	<ul style="list-style-type: none"> <li>Turns on if an error is detected by self-diagnostics.</li> <li>The on state remains even after the system returns to normal.</li> </ul>	
SM5	Error common information	OFF: No error common information ON: Error common information exists	Turns on if there is any error common information when SM0 turns on.	
SM16	Error individual information	OFF: No error individual information ON: Error individual information exists	Turns on if there is any error individual information when SM0 turns on.	
SM50	Error clear	OFF → ON: Error clear	Clears the error detected.	U
SM53	AC/DC DOWN detection	OFF: AC/DC DOWN not detected	Turns on if a momentary power failure within 10ms occurs when an AC power supply module is being used. The on state is reset when the system is powered off and on.	S (Error)
		ON: AC/DC DOWN detected	Turns on if a momentary power failure within 10ms occurs when a DC power supply module is being used. The on state is reset when the system is powered off and on.	
SM61	I/O module verify error	OFF: Normal ON: Error	<ul style="list-style-type: none"> <li>Turns on if the status of the I/O module at power-on differs from the registered status.</li> <li>The on state remains even after the system returns to normal.</li> </ul>	

**(2) System clock/counter**

No.	Name	Meaning	Explanation	Set by (Set timing)
SM400	Always ON	ON _____ OFF	This relay is always on.	S (Initial)
SM401	Always OFF	ON OFF _____	This relay is always off.	

**(3) Drive information**

No.	Name	Meaning	Explanation	Set by (Set timing)
SM681	Parameter memory writing flag	ON: Data being written OFF: Data not being written	Turns on while data (such as parameters) are written to the flash ROM, and turns off when the writing is completed.	S (Write)
SM682	Parameter memory overwrite count error flag	ON: Overwrite count reached 100000 OFF: Overwrite count less than 100000	Turns on when overwrite count of data (such as parameters) to the flash ROM reaches 100000. (The head module needs to be replaced.)	

## Appendix 7 Special Register (SD)

---

The special register (SD) is an internal register whose application is determined in the programmable controller. However, data can be written to the special register to control the head module as needed. Data is stored in binary format if not specified.

The following table shows how to read the list of special register areas.

Item	Description
No.	Special register number
Name	Special register name
Meaning	Contents of the special register
Explanation	Detailed description of the special register
Set by (Set timing)	Set side and set timing of the special register <Set by> .S: Set by the system. .U: Set by a user (via network or by test operation from GX Works2). .S/U: Set by both the system and a user. <Set timing> The set timing is described only for the special relay areas set by the system. .Initial: During initial processing (after power-on or reset) .Status change: When the operating status is changed .Error: When an error occurs .Switch change: When the switch is changed .Write: When data are written to the module

---

### **Point**

Do not change the value of any special register areas set by the system by performing test operation. Doing so may result in system down or communication failure.

---

(1) Diagnostic information

No.	Name	Meaning	Explanation	Set by (Set timing)
SD0	Diagnostic error	Diagnostic error code	<ul style="list-style-type: none"> <li>Stores the error code of an error detected by diagnostics.</li> <li>The stored data is the same as the latest information in error history and system error history.</li> </ul>	S (Error)
SD1	Clock time of diagnostic error occurrence	Clock time of diagnostic error occurrence	Stores the year (last two digits) and the month in two-digit BCD code when the data in SD0 is updated. b15 to b8 b7 to b0 (Example) January, 2010 Year (0 to 99)   Month (1 to 12) 1001H The clock of the head module synchronizes with the clock of the master station. (☞ Page 26, Section 3.2)	
SD2			Stores the day and the hour in two-digit BCD code when the data in SD0 is updated. b15 to b8 b7 to b0 (Example) 10 a.m. on 25th Day (1 to 31)   Hour (0 to 23) 2510H The clock of the head module synchronizes with the clock of the master station. (☞ Page 26, Section 3.2)	
SD3			Stores the minute and the second in two-digit BCD code when the data in SD0 is updated. b15 to b8 b7 to b0 (Example) 35 min. 48 sec. Minutes (0 to 59)   Seconds (0 to 59) 3548H The clock of the head module synchronizes with the clock of the master station. (☞ Page 26, Section 3.2)	
SD4	Error information category	Error information category code	<ul style="list-style-type: none"> <li>Error information is stored in Error common information (SD5 to SD15) and Error individual information (SD16 to SD26).</li> <li>A category code indicating an error information type is stored here.                      b15 to b8 b7 to b0                      Individual information category codes   Common information category codes</li> <li>The following codes are stored as a common information category code.                      .0: No error                      .1: Module No. (Slot No.)                      .2: File name/drive name                      .3: Time (value set)</li> <li>The following codes are stored as a individual information category code.                      .0: No error                      .1: (Empty)                      .2: File name/drive name                      .3: Time (value actually measured)                      .4: No error                      .5: Parameter No.                      .6: No error                      .7: No error                      .8: No error                      .9: Failure information                      .12: File diagnostic information                      .13: No error</li> </ul>	S (Error)

No.	Name	Meaning	Explanation	Set by (Set timing)																																																		
SD5	Error common information	Error common information	<ul style="list-style-type: none"> <li>Stores common information corresponding to the error code stored in SD0.</li> <li>The following three types of information are stored here.</li> <li>The error common information type can be determined by "common information category code" stored in SD4. (The values stored in "common information category code" correspond to the following 1) to 3.)</li> </ul> <p>1) Module No.</p> <table border="1"> <thead> <tr> <th>Number</th> <th>Meaning</th> </tr> </thead> <tbody> <tr> <td>SD5</td> <td>Slot No. * 1, * 2</td> </tr> <tr> <td>SD6</td> <td>I/O No. * 3</td> </tr> <tr> <td>SD7</td> <td rowspan="9">(Empty)</td> </tr> <tr> <td>SD8</td> </tr> <tr> <td>SD9</td> </tr> <tr> <td>SD10</td> </tr> <tr> <td>SD11</td> </tr> <tr> <td>SD12</td> </tr> <tr> <td>SD13</td> </tr> <tr> <td>SD14</td> </tr> <tr> <td>SD15</td> </tr> </tbody> </table> <p>*1 The slot number is defined as follows: [Slot No.] This value identifies the connected module. The module connected to the right of the head module is considered "Slot No. = 0", and the rest of the modules are numbered incrementally in series.</p> <p>*2 If a module is not mounted on any slots as set, FFH is stored.</p> <p>*3 If FFFFH is stored in SD6 (I/O No.), this indicates that the I/O No. cannot be identified due to an error such as overlap of an I/O No. in the "I/O Assignment" tab of PLC parameter. In this case, identify the error location using SD5.</p> <p>2) File name/drive name</p> <table border="1"> <thead> <tr> <th>Number</th> <th>Meaning</th> </tr> </thead> <tbody> <tr> <td>SD5</td> <td>Drive</td> </tr> <tr> <td>SD6</td> <td rowspan="4">File name (ASCII code: 8 characters)</td> </tr> <tr> <td>SD7</td> </tr> <tr> <td>SD8</td> </tr> <tr> <td>SD9</td> </tr> <tr> <td>SD10</td> <td>Extension * 4   2EH(.)</td> </tr> <tr> <td>SD11</td> <td>(ASCII code: 3 characters)</td> </tr> <tr> <td>SD12</td> <td rowspan="4">(Empty)</td> </tr> <tr> <td>SD13</td> </tr> <tr> <td>SD14</td> </tr> <tr> <td>SD15</td> </tr> </tbody> </table> <p>(Example) File name = ABCDEFGHIJ. IJK b15 to b8 b7 to b0 42H(B) 41H(A) 44H(D) 43H(C) 46H(F) 45H(E) 48H(H) 47H(G) 49H(I) 2EH(.) 4BH(K) 4AH(J)</p> <p>3) Time (value set)</p> <table border="1"> <thead> <tr> <th>Number</th> <th>Meaning</th> </tr> </thead> <tbody> <tr> <td>SD5</td> <td>Time : 1μs units (0 to 999μs)</td> </tr> <tr> <td>SD6</td> <td>Time : 1ms units (0 to 65535ms)</td> </tr> <tr> <td>SD7</td> <td rowspan="9">(Empty)</td> </tr> <tr> <td>SD8</td> </tr> <tr> <td>SD9</td> </tr> <tr> <td>SD10</td> </tr> <tr> <td>SD11</td> </tr> <tr> <td>SD12</td> </tr> <tr> <td>SD13</td> </tr> <tr> <td>SD14</td> </tr> <tr> <td>SD15</td> </tr> </tbody> </table> <p>*4 For extension names, refer to the table below on this page.</p>	Number	Meaning	SD5	Slot No. * 1, * 2	SD6	I/O No. * 3	SD7	(Empty)	SD8	SD9	SD10	SD11	SD12	SD13	SD14	SD15	Number	Meaning	SD5	Drive	SD6	File name (ASCII code: 8 characters)	SD7	SD8	SD9	SD10	Extension * 4   2EH(.)	SD11	(ASCII code: 3 characters)	SD12	(Empty)	SD13	SD14	SD15	Number	Meaning	SD5	Time : 1μs units (0 to 999μs)	SD6	Time : 1ms units (0 to 65535ms)	SD7	(Empty)	SD8	SD9	SD10	SD11	SD12	SD13	SD14	SD15	S (Error)
Number				Meaning																																																		
SD5				Slot No. * 1, * 2																																																		
SD6				I/O No. * 3																																																		
SD7				(Empty)																																																		
SD8																																																						
SD9																																																						
SD10																																																						
SD11																																																						
SD12																																																						
SD13																																																						
SD14																																																						
SD15																																																						
Number				Meaning																																																		
SD5				Drive																																																		
SD6	File name (ASCII code: 8 characters)																																																					
SD7																																																						
SD8																																																						
SD9																																																						
SD10	Extension * 4   2EH(.)																																																					
SD11	(ASCII code: 3 characters)																																																					
SD12	(Empty)																																																					
SD13																																																						
SD14																																																						
SD15																																																						
Number	Meaning																																																					
SD5	Time : 1μs units (0 to 999μs)																																																					
SD6	Time : 1ms units (0 to 65535ms)																																																					
SD7	(Empty)																																																					
SD8																																																						
SD9																																																						
SD10																																																						
SD11																																																						
SD12																																																						
SD13																																																						
SD14																																																						
SD15																																																						

### (a) Extension names

SD <sub>n</sub>	SD <sub>n+1</sub>		Extension name	File type
	Upper 8 bits	Lower 8 bits		
51H	50H	41H	QPA	Parameter
51H	44H	49H	QDI	Initial device value

No.	Name	Meaning	Explanation	Set by (Set timing)																																	
SD16	Error individual information	Error individual information	<ul style="list-style-type: none"> <li>Stores individual information corresponding to the error code stored in SD0.</li> <li>The following six types of information are stored here.</li> <li>The error individual information type can be determined by "individual information category code" stored in SD4. (The values stored in "individual information category code" correspond to the following 1) to 6.)</li> </ul>	S (Error)																																	
SD17			1) (Empty) 2) File name/drive name <table border="1" style="margin-left: 20px;"> <thead> <tr> <th>Number</th> <th>Meaning</th> </tr> </thead> <tbody> <tr> <td>SD16</td> <td>Drive</td> </tr> <tr> <td>SD17</td> <td rowspan="2">File name</td> </tr> <tr> <td>SD18</td> <td>(ASCII code: 8 characters)</td> </tr> <tr> <td>SD19</td> <td rowspan="2">Extension *4</td> </tr> <tr> <td>SD20</td> <td>2EH(.)</td> </tr> <tr> <td>SD21</td> <td rowspan="2">(ASCII code: 3 characters)</td> </tr> <tr> <td>SD22</td> <td>(Empty)</td> </tr> <tr> <td>SD23</td> <td rowspan="4">(Empty)</td> </tr> <tr> <td>SD24</td> </tr> <tr> <td>SD25</td> </tr> <tr> <td>SD26</td> </tr> </tbody> </table> <div style="margin-left: 20px;">                     (Example) File name =                      ABCDEFGH, IJK                      b15 to b8 b7 to b0  <table border="1" style="margin-left: 20px;"> <tr> <td>42H(B)</td> <td>41H(A)</td> </tr> <tr> <td>44H(D)</td> <td>43H(C)</td> </tr> <tr> <td>46H(F)</td> <td>45H(E)</td> </tr> <tr> <td>48H(H)</td> <td>47H(G)</td> </tr> <tr> <td>49H(I)</td> <td>2EH(.)</td> </tr> <tr> <td>4BH(K)</td> <td>4AH(J)</td> </tr> </table> </div>		Number	Meaning	SD16	Drive	SD17	File name	SD18	(ASCII code: 8 characters)	SD19	Extension *4	SD20	2EH(.)	SD21	(ASCII code: 3 characters)	SD22	(Empty)	SD23	(Empty)	SD24	SD25	SD26	42H(B)	41H(A)	44H(D)	43H(C)	46H(F)	45H(E)	48H(H)	47H(G)	49H(I)	2EH(.)	4BH(K)	4AH(J)
Number			Meaning																																		
SD16			Drive																																		
SD17			File name																																		
SD18					(ASCII code: 8 characters)																																
SD19			Extension *4																																		
SD20					2EH(.)																																
SD21			(ASCII code: 3 characters)																																		
SD22					(Empty)																																
SD23			(Empty)																																		
SD24																																					
SD25																																					
SD26																																					
42H(B)			41H(A)																																		
44H(D)			43H(C)																																		
46H(F)			45H(E)																																		
48H(H)			47H(G)																																		
49H(I)			2EH(.)																																		
4BH(K)			4AH(J)																																		
SD18			3) Time (value actually measured) <table border="1" style="margin-left: 20px;"> <thead> <tr> <th>Number</th> <th>Meaning</th> </tr> </thead> <tbody> <tr> <td>SD16</td> <td>Time : 1 μs units (0 to 999 μs)</td> </tr> <tr> <td>SD17</td> <td>Time : 1ms units (0 to 65535ms)</td> </tr> <tr> <td>SD18</td> <td rowspan="10">(Empty)</td> </tr> <tr> <td>SD19</td> </tr> <tr> <td>SD20</td> </tr> <tr> <td>SD21</td> </tr> <tr> <td>SD22</td> </tr> <tr> <td>SD23</td> </tr> <tr> <td>SD24</td> </tr> <tr> <td>SD25</td> </tr> <tr> <td>SD26</td> </tr> </tbody> </table>		Number	Meaning	SD16	Time : 1 μs units (0 to 999 μs)	SD17	Time : 1ms units (0 to 65535ms)	SD18	(Empty)	SD19	SD20	SD21	SD22	SD23	SD24	SD25	SD26																	
Number			Meaning																																		
SD16			Time : 1 μs units (0 to 999 μs)																																		
SD17			Time : 1ms units (0 to 65535ms)																																		
SD18			(Empty)																																		
SD19																																					
SD20																																					
SD21																																					
SD22																																					
SD23																																					
SD24																																					
SD25																																					
SD26																																					
SD19																																					
SD20																																					
SD21	*4 For extension names, refer to the table on Page 130, Appendix 7 (1) (a). 4) Parameter No. <table border="1" style="margin-left: 20px;"> <thead> <tr> <th>Number</th> <th>Meaning</th> </tr> </thead> <tbody> <tr> <td>SD16</td> <td>Parameter No. *5</td> </tr> <tr> <td>SD17</td> <td rowspan="10">(Empty)</td> </tr> <tr> <td>SD18</td> </tr> <tr> <td>SD19</td> </tr> <tr> <td>SD20</td> </tr> <tr> <td>SD21</td> </tr> <tr> <td>SD22</td> </tr> <tr> <td>SD23</td> </tr> <tr> <td>SD24</td> </tr> <tr> <td>SD25</td> </tr> <tr> <td>SD26</td> </tr> </tbody> </table>	Number	Meaning	SD16	Parameter No. *5	SD17	(Empty)	SD18	SD19	SD20	SD21	SD22	SD23	SD24	SD25	SD26																					
Number	Meaning																																				
SD16	Parameter No. *5																																				
SD17	(Empty)																																				
SD18																																					
SD19																																					
SD20																																					
SD21																																					
SD22																																					
SD23																																					
SD24																																					
SD25																																					
SD26																																					
SD22																																					
SD23	*5 For details on parameter numbers, refer to the following. Page 51, CHAPTER 7 5) Failure information <table border="1" style="margin-left: 20px;"> <thead> <tr> <th>Number</th> <th>Meaning</th> </tr> </thead> <tbody> <tr> <td>SD16</td> <td>Failure information 1</td> </tr> <tr> <td>SD17</td> <td>Failure information 2</td> </tr> <tr> <td>SD18</td> <td>Failure information 3</td> </tr> <tr> <td>SD19</td> <td>Failure information 4</td> </tr> <tr> <td>SD20</td> <td>Failure information 5</td> </tr> <tr> <td>SD21</td> <td>Failure information 6</td> </tr> <tr> <td>SD22</td> <td>Failure information 7</td> </tr> <tr> <td>SD23</td> <td>Failure information 8</td> </tr> <tr> <td>SD24</td> <td>Failure information 9</td> </tr> <tr> <td>SD25</td> <td>Failure information 10</td> </tr> <tr> <td>SD26</td> <td>Failure information 11</td> </tr> </tbody> </table>	Number	Meaning	SD16	Failure information 1	SD17	Failure information 2	SD18	Failure information 3	SD19	Failure information 4	SD20	Failure information 5	SD21	Failure information 6	SD22	Failure information 7	SD23	Failure information 8	SD24	Failure information 9	SD25	Failure information 10	SD26	Failure information 11												
Number	Meaning																																				
SD16	Failure information 1																																				
SD17	Failure information 2																																				
SD18	Failure information 3																																				
SD19	Failure information 4																																				
SD20	Failure information 5																																				
SD21	Failure information 6																																				
SD22	Failure information 7																																				
SD23	Failure information 8																																				
SD24	Failure information 9																																				
SD25	Failure information 10																																				
SD26	Failure information 11																																				
SD24																																					
SD25	6) File diagnostic information <table border="1" style="margin-left: 20px;"> <thead> <tr> <th>Number</th> <th>Meaning</th> </tr> </thead> <tbody> <tr> <td>SD16</td> <td>Failure information (H)   drive No.(L)</td> </tr> <tr> <td>SD17</td> <td rowspan="4">File name (ASCII: 8 characters)</td> </tr> <tr> <td>SD18</td> </tr> <tr> <td>SD19</td> </tr> <tr> <td>SD20</td> </tr> <tr> <td>SD21</td> <td>Extension*4   2EH(.)</td> </tr> <tr> <td>SD22</td> <td>(ASCII; 3 characters)</td> </tr> <tr> <td>SD23</td> <td>Failure information 2</td> </tr> <tr> <td>SD24</td> <td>(CRC value that is read)</td> </tr> <tr> <td>SD25</td> <td>Failure information 3</td> </tr> <tr> <td>SD26</td> <td>(CRC value that is calculated)</td> </tr> </tbody> </table>	Number	Meaning	SD16	Failure information (H)   drive No.(L)	SD17	File name (ASCII: 8 characters)	SD18	SD19	SD20	SD21	Extension*4   2EH(.)	SD22	(ASCII; 3 characters)	SD23	Failure information 2	SD24	(CRC value that is read)	SD25	Failure information 3	SD26	(CRC value that is calculated)															
Number	Meaning																																				
SD16	Failure information (H)   drive No.(L)																																				
SD17	File name (ASCII: 8 characters)																																				
SD18																																					
SD19																																					
SD20																																					
SD21	Extension*4   2EH(.)																																				
SD22	(ASCII; 3 characters)																																				
SD23	Failure information 2																																				
SD24	(CRC value that is read)																																				
SD25	Failure information 3																																				
SD26	(CRC value that is calculated)																																				
SD26	*4 For extension names, refer to the table on Page 130, Appendix 7 (1) (a).																																				

No.	Name	Meaning	Explanation	Set by (Set timing)
SD50	Error clear	Error code to be cleared	Stores the error code to be cleared.	U
SD53	AC/DC DOWN detection	AC/DC DOWN detection count	<ul style="list-style-type: none"> <li>• Each time the input voltage of the head module drops below 85% (AC power)/65% (DC power) of the rated voltage, the value is incremented by 1 and is stored here.</li> <li>• The counter repeats increment and decrement of the value: 0 → 32767 → -32768 → 0.</li> </ul>	S (Error)
SD61	I/O module verify error number	I/O module verify error module number	Stores the lowest I/O number of the module where the I/O module verify error has occurred.	

(2) System information

No.	Name	Meaning	Explanation	Set by (Set timing)																											
SD200	Status of switch	Head module switch status	Stores the switch status of the head module. 0: RUN 1: STOP/RESET	S (Switch change)																											
SD201	LED status	Head module LED status	<ul style="list-style-type: none"> <li>Stores the status of each LED of the head module in the following bit pattern.</li> <li>0 = Off, 1 = On, 2 = Flashing</li> </ul> <p>1): REM., 2): ERR., 3): D LINK, 4): Empty, 5): RD, 6): SD, 7): MODE, 8): RUN (While offline, the RD and SD LEDs are always off.)</p>	S (Status change)																											
SD203	Operating status	Operating status	<p>Stores the operating status of the head module.</p> <p>1) Operating status 0: RUN, 2: STOP 2) Cause of STOP The latest cause of the change in the operating status is stored. 0: STOP switch 1: Master station STOP 2: Remote operation from GX Works2 4: Error 3) Empty</p>	S (Status change)																											
SD220	HMI data	HMI data	Stores the ASCII data (16 characters) of the HMI.	S (Change)																											
SD221			<table border="1"> <thead> <tr> <th></th> <th>b15 to b8</th> <th>b7 to b0</th> </tr> </thead> <tbody> <tr> <td>SD220</td> <td>15th character from the right</td> <td>16th character from the right</td> </tr> <tr> <td>SD221</td> <td>13th character from the right</td> <td>14th character from the right</td> </tr> <tr> <td>SD222</td> <td>11th character from the right</td> <td>12th character from the right</td> </tr> <tr> <td>SD223</td> <td>9th character from the right</td> <td>10th character from the right</td> </tr> <tr> <td>SD224</td> <td>7th character from the right</td> <td>8th character from the right</td> </tr> <tr> <td>SD225</td> <td>5th character from the right</td> <td>6th character from the right</td> </tr> <tr> <td>SD226</td> <td>3rd character from the right</td> <td>4th character from the right</td> </tr> <tr> <td>SD227</td> <td>1st character from the right</td> <td>2nd character from the right</td> </tr> </tbody> </table>			b15 to b8	b7 to b0	SD220	15th character from the right	16th character from the right	SD221	13th character from the right	14th character from the right	SD222	11th character from the right	12th character from the right	SD223	9th character from the right	10th character from the right	SD224	7th character from the right	8th character from the right	SD225	5th character from the right	6th character from the right	SD226	3rd character from the right	4th character from the right	SD227	1st character from the right	2nd character from the right
					b15 to b8	b7 to b0																									
SD220					15th character from the right	16th character from the right																									
SD221					13th character from the right	14th character from the right																									
SD222					11th character from the right	12th character from the right																									
SD223					9th character from the right	10th character from the right																									
SD224					7th character from the right	8th character from the right																									
SD225	5th character from the right	6th character from the right																													
SD226	3rd character from the right	4th character from the right																													
SD227	1st character from the right	2nd character from the right																													
SD222																															
SD223																															
SD224																															
SD225																															
SD226																															
SD227																															
SD250	Loaded maximum I/O	Loaded maximum I/O number	Stores the upper two digits of the last I/O number of the connected module + 1.	S (Initial)																											
SD286	Device assignment	Number of points assigned to M (for extension)	Stores the number of points assigned to M (for extension). The number of points is fixed to 0.																												
SD287			Stores the number of points assigned to M (for extension). The number of points is fixed to 0.																												
SD288		Number of points assigned to B (for extension)	Stores the number of points assigned to B (for extension). The number of points is fixed to 0.																												
SD289			Stores the number of points assigned to B (for extension). The number of points is fixed to 0.																												

No.	Name	Meaning	Explanation	Set by (Set timing)
SD290	Device assignment 1	Number of points assigned to X	Stores the number of points assigned to X. The number of points is fixed to 8192.	S (Initial)
SD291		Number of points assigned to Y	Stores the number of points assigned to Y. The number of points is fixed to 8192.	
SD292		Number of points assigned to M	Stores the number of points assigned to M. The number of points is fixed to 0.	
SD293		Number of points assigned to L	Stores the number of points assigned to L. The number of points is fixed to 0.	
SD294		Number of points assigned to B	Stores the number of points assigned to B. The number of points is fixed to 0.	
SD295		Number of points assigned to F	Stores the number of points assigned to F. The number of points is fixed to 0.	
SD296		Number of points assigned to SB	Stores the number of points assigned to SB. The number of points is fixed to 8192.	
SD297		Number of points assigned to V	Stores the number of points assigned to V. The number of points is fixed to 0.	
SD298		Number of points assigned to S	Stores the number of points assigned to S. The number of points is fixed to 0.	
SD299		Number of points assigned to T	Stores the number of points assigned to T. The number of points is fixed to 0.	
SD300		Number of points assigned to ST	Stores the number of points assigned to ST. The number of points is fixed to 0.	
SD301		Number of points assigned to C	Stores the number of points assigned to C. The number of points is fixed to 0.	
SD302		Number of points assigned to D	Stores the number of points assigned to D. The number of points is fixed to 0.	
SD303		Number of points assigned to W	Stores the number of points assigned to W. The number of points is fixed to 8192.	
SD304		Number of points assigned to SW	Stores the number of points assigned to SW. The number of points is fixed to 8192.	
SD305		Device assignment 1 (Index register)	16-bit modification, number of points assigned to Z	
SD306	Device assignment 1	Number of points assigned to ZR (for extension)	Stores the number of points assigned to ZR (for extension). The number of points is fixed to 0.	
SD307				
SD308	Device assignment 2 (Assignment including the number of points set to the extended data register (D) and extended link register (W))	Number of points assigned to D (for internal and extension)	Stores the number of points assigned to D (including the extended data register). The number of points is fixed to 0.	
SD309				
SD310		Number of points assigned to W (for internal and extension)	Stores the number of points assigned to W (including the extended link register). The number of points is fixed to 8192.	
SD311				



### (3) Drive information

No.	Name	Meaning	Explanation	Set by (Set timing)
SD681	Parameter memory write (transfer) status	Write (transfer) status display (percentage)	Stores the progress of writing (transfer) to the program memory (flash ROM) in percentage (0 to 100%). "0" is set when the write (transfer) command is issued.	S (Write)
SD682	Parameter memory write count index	Write count index up to the present	Stores the index value of write count to the program memory (flash ROM) <sup>*1</sup> up to the present in 32-bit binary. When the index value exceeds 100 thousand times, "FLASH ROM ERROR" (error code: 1610) occurs. (The index value will be counted even after it exceeds 100 thousand.)	
SD683				

\*1 The write count is not equal to the index value. (Since the maximum write count of the flash ROM has been increased by the system, the value increments by one about every two write operations.)

### (4) Debugging

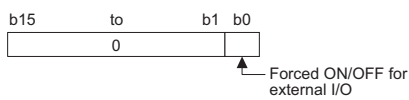
No.	Name	Meaning	Explanation	Set by (Set timing)
SD840	Debug function usage	Debug function usage	<p>Stores the status of the following debug function.</p> <p>0: External input/output forced on/off function</p> <p>1 to 15: Empty (fixed to 0)</p>  <p>(0: Not used, 1: Used)</p>	S (Status change)

### (5) I/O module verification

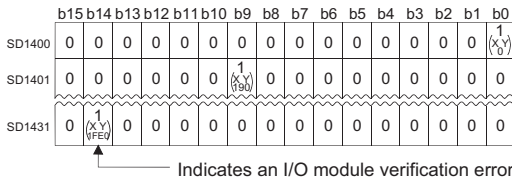
No.	Name	Meaning	Explanation	Set by (Set timing)
SD1400	I/O module verify error	Bit pattern, in units of 16 points, indicating the modules with verification errors	<p>• If the status of the I/O module changes from that obtained at power-on, the module No. is stored in the following bit pattern. (If the I/O module numbers are set in parameter, the parameter-set numbers are stored.)</p>  <p>Indicates an I/O module verification error</p> <p>When the number of I/O points of the module exceeds 16 points, all bits corresponding to the I/O module number (in units of 16 points) that is included in the number of I/O points occupied by the module turn on.</p> <p>Example: When a 64-point module is mounted on the slot 0, b0 to b3 turn on when an error is detected.</p> <p>• The values are not cleared even after the system returns to normal. To clear the values, clear the error.</p>	S (Error)
SD1401				
SD1402				
SD1403				
SD1404				
SD1405				
SD1406				
SD1407				
SD1408				
SD1409 to SD1430				
SD1431				

## Appendix 8 Access Code and Attribute Code

---

The following table lists the access codes and attribute code that are set when accessing the head module by using the RIRD or RIWT instruction of the master/local module.

Device <sup>*1</sup>	Name	Device type		Unit	Access code	Attribute code
		Bit	Word			
Input	X	○		Hexadecimal	01H	05H
Output	Y	○		Hexadecimal	02H	
Link register	W		○	Hexadecimal	24H	
Link special relay	SB	○		Hexadecimal	63H	
Link special register	SW		○	Hexadecimal	64H	
Special relay	SM	○		Decimal	43H	
Special register	SD		○	Decimal	44H	

\*1 Devices not listed in the table cannot be accessed.  
To access a bit device, specify 0 or a multiple of 16.

# Appendix 9 EMC and Low Voltage Directives

A

Compliance with the EMC Directive, which is one of the EU directives, has been mandatory for products sold within EU member states since 1996 as well as compliance with the Low Voltage Directive since 1997.

For products compliant to the EMC and Low Voltage Directives, their manufacturers are required to declare compliance and affix the CE marking.

## (1) Sales representative in EU member states

The sales representative in EU member states is:

Company: MITSUBISHI ELECTRIC EUROPE B.V.

Address: Mitsubishi-Electric-Platz 1, 40882 Ratingen, Germany

## Appendix 9.1 Measures to comply with the EMC Directive

The EMC Directive sets requirements for emission (conducted and radiated electromagnetic interference emitted by a product) and immunity (the ability of a product not to be influenced by externally generated electromagnetic interference).

This section describes the precautions for machinery constructed with the MELSEC-L series modules to comply with the EMC Directive.

These precautions are based on the requirements of the EMC Directive and the harmonized standards. However, they do not guarantee that the entire machinery constructed according to the descriptions complies with the EMC Directive. The manufacturer of the machinery must determine the testing method for compliance and declare conformity to the EMC Directive.

### (1) EMC Directive related standards

#### (a) Emission requirements

Standard	Test item	Test description	Value specified in standard
EN61131-2: 2007	CISPR16-2-3 Radiated emission* <sup>2</sup>	The electromagnetic wave emitted by the product to the external space is measured.	<ul style="list-style-type: none"> <li>• 30 to 230MHz, QP: 40dB<math>\mu</math>V/m (measured at 10m distance)*<sup>1</sup></li> <li>• 230 to 1000MHz, QP: 47dB<math>\mu</math>V/m (measured at 10m distance)</li> </ul>
	CISPR16-2-1, CISPR16-1-2 Conducted emission* <sup>2</sup>	The noise level which the product emits to the power line is measured.	<ul style="list-style-type: none"> <li>• 0.15 to 0.5MHz, QP: 79dB, Mean: 66dB *<sup>1</sup></li> <li>• 0.5 to 30MHz, QP: 73dB, Mean: 60dB</li> </ul>

\*1 QP: Quasi-Peak value, Mean: Average value

\*2 Programmable controller is an open-type device intended to be placed in a conductive control panel or similar type of enclosure. The tests were conducted with the programmable controller installed in a control panel, applying the maximum rated input voltage of the power supply module.

## (b) Immunity requirements

Standard	Test item	Test description	Value specified in standard
EN61131-2: 2007	EN61000-4-2 Electrostatic discharge immunity* <sup>1</sup>	An electrostatic discharge is applied to the enclosure of the equipment.	<ul style="list-style-type: none"> <li>• 8kV: Air discharge</li> <li>• 4kV: Contact discharge</li> </ul>
	EN61000-4-3 Radiated, radio-frequency, electromagnetic field immunity* <sup>1</sup>	An electric field is radiated to the product.	80% AM modulation @1kHz <ul style="list-style-type: none"> <li>• 80 to 1000MHz: 10Vm</li> <li>• 1.4 to 2.0GHz: 3Vm</li> <li>• 2.0 to 2.7GHz: 1Vm</li> </ul>
	EN61000-4-4 Fast transient burst immunity* <sup>1</sup>	Burst noise is applied to power lines and signal lines.	<ul style="list-style-type: none"> <li>• AC/DC power, I/O power, and AC I/O (unshielded) lines: 2kV</li> <li>• DC I/O, analog, and communication lines: 1kV</li> </ul>
	EN61000-4-5 Surge immunity* <sup>1</sup>	Lightning surge is applied to power lines and signal lines.	<ul style="list-style-type: none"> <li>• AC power, AC I/O power, and AC I/O (unshielded) lines: 2kV CM, 1kV DM</li> <li>• DC power and DC I/O power lines: 0.5kV CM, 0.5kV DM</li> <li>• DC I/O, AC I/O (shielded), analog*<sup>2</sup>, and communication lines: 1kV CM</li> </ul>
	EN61000-4-6 Conducted RF immunity* <sup>1</sup>	High-frequency noise is applied to power lines and signal lines.	0.15 to 80MHz, 80% AM modulation @1kHz, 10Vrms
	EN61000-4-8 Power-frequency magnetic field immunity* <sup>1</sup>	The product is immersed in the magnetic field of an induction coil.	50/60Hz, 30A/m
	EN61000-4-11 Voltage dips and interruption immunity* <sup>1</sup>	Power voltage is momentarily interrupted.	<ul style="list-style-type: none"> <li>• 0%, 0.5 period, starting at zero-crossing</li> <li>• 0%, 250/300 period (50/60Hz)</li> <li>• 40%, 10/12 period (50/60Hz)</li> <li>• 70%, 25/30 period (50/60Hz)</li> </ul>

\*1 Programmable controller is an open-type device intended to be placed in a conductive control panel or similar type of enclosure. The tests were conducted with the programmable controller installed in a control panel.

\*2 The accuracy of an analog-digital converter module may temporarily vary within  $\pm 10\%$ .

## (2) Installation in a control panel

Programmable controller is an open-type device intended to be placed in a conductive control panel or similar type of enclosure.\*<sup>1</sup>

This ensures safety as well as effective shielding of electromagnetic noise emitted from the programmable controller.

\*1 Remote modules on each network must be also installed inside the control panel. Waterproof type remote modules can be installed outside the control panel.

### (a) Control panel

- Use a conductive control panel.
- Mask off an area used for grounding in advance.
- To ensure electrical contact between inner plates and the control panel, mask off the bolt installation areas of each inner plate so that conductivity can be ensured in the largest area.
- Ground the control panel with a thick ground cable so that low impedance can be ensured even at high frequencies.

- Keep the diameter of the holes on the control panel to 10cm or less. If the diameter is larger than 10cm, electromagnetic wave may leak. In addition, because electromagnetic wave leaks through a clearance between the control panel and its door, reduce the clearance as much as possible. Use of EMI gaskets (sealing the clearance) can suppress undesired radiated emissions.

The tests were conducted by Mitsubishi Electric Corporation using a control panel having damping characteristics of 37dB (maximum) and 30dB (average) (measured at 3m distance, 30 to 300MHz).

### (b) Power cable and ground cable

- Provide a ground point to the control panel near the power supply module. Ground the LG and FG terminals of the power supply module to the ground point with the thickest and shortest ground cable possible (30cm or shorter).

### (3) CC-Link IE Field Network cable

The precautions for using CC-Link IE Field Network cables are described below.

- For CC-Link IE Field Network module, use CC-Link IE Field Network cables (SC-E5EW-S□M, manufactured by Mitsubishi Electric System & Service Co., Ltd.).
- A CC-Link IE Field Network cable is a shielded cable. Strip a part of the jacket of the cable as shown below and ground the exposed shield to the largest area.

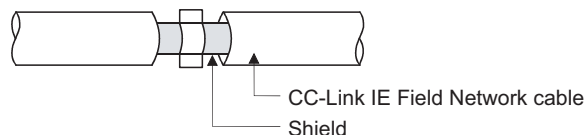

- Use shielded cables for external wiring and ground the shields of the shielded cables to the control panel with an AD75CK cable clamp (manufactured by Mitsubishi). (Ground the shields within 20 to 30cm from the module.)

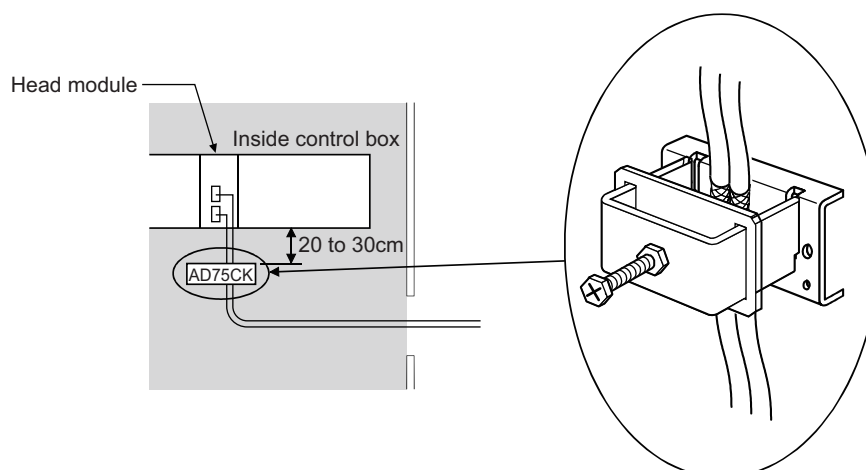

#### (4) Cables used for the modules connected to the head module

When a cable connected to a module such as an I/O module is extended out of the control panel, use a shielded cable.

If a shielded cable is not used or not grounded properly, the noise immunity will not meet the requirement.

##### (a) Grounding a shielded cable

- Ground the shield of a shielded cable as close to the module as possible so that the grounded cable will not be affected by electromagnetic induction from ungrounded cables.
- Ground the exposed shield to a large area on the control panel. A clamp can be used as shown below. In this case, mask off the inner wall surface of the control panel, which comes in contact with the clamp.

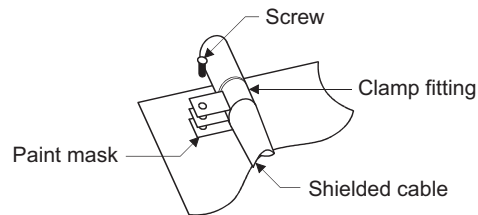

##### **Point!**

- Do not use the tip of a PVC wire soldered onto a shield of the shielded cable for grounding. Doing so will raise the high-frequency impedance, resulting in loss of the shielding effect.

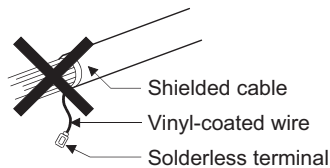

##### (b) Grounding a twisted pair cable

- Use a shielded twisted pair cable for connection to the 10BASE-T or 100BASE-TX connector. Strip a part of the jacket of the shielded twisted pair cable as shown below and ground the exposed shield to the largest area.

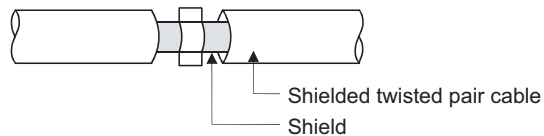

**(c) Grounding a Ver.1.10-compatible CC-Link dedicated cable**

Ground the shield of a cable connected to the CC-Link module or any of the CC-Link stations which is the farthest from the input power inside the control panel within 30cm from the module or station.

Ver.1.10-compatible CC-Link dedicated cable is a shielded cable Strip a part of the jacket of the cable as shown below and ground the exposed shield to the largest area.

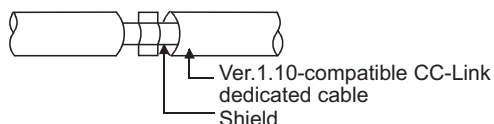

Use the specified Ver.1.10-compatible CC-Link dedicated cable.

Use the FG terminals of the CC-Link module and CC-Link stations as shown below to connect to the FG line inside the control panel.

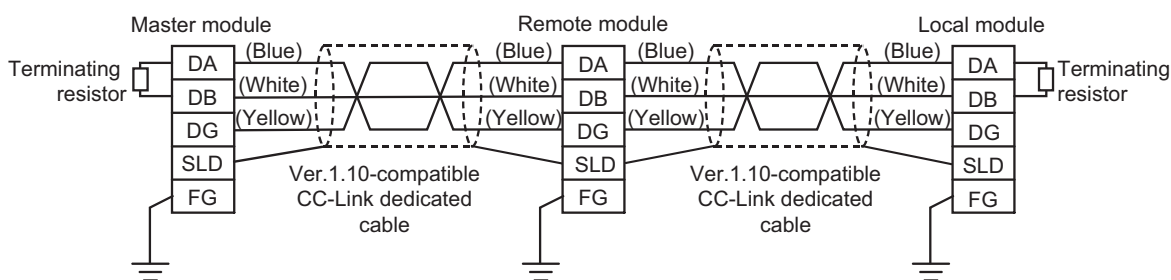

**(d) Grounding cables with a cable clamp**

Use shielded cables for external wiring and ground the shields of the shielded cables to the control panel with an AD75CK cable clamp (manufactured by Mitsubishi). (Ground the shields within 20 to 30cm from the module.)

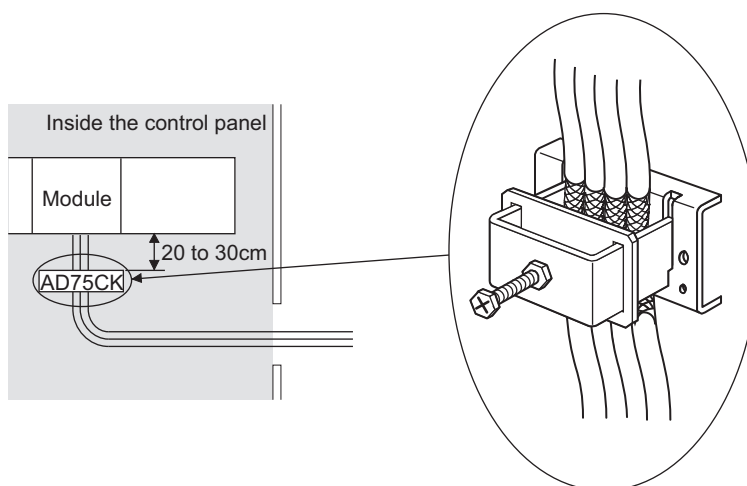

For details on the AD75CK, refer to the following.

AD75CK-type Cable Clamping Instruction Manual

### (e) Connectors for external devices

When using connectors for external devices with any of the following modules, take the noise reduction measures described below.

- High-speed counter module
- Positioning module
- Flexible high-speed I/O control module

[When shielded cables are connected]

The following figure shows an example of wiring against noise when a connector (A6CON1) is used.

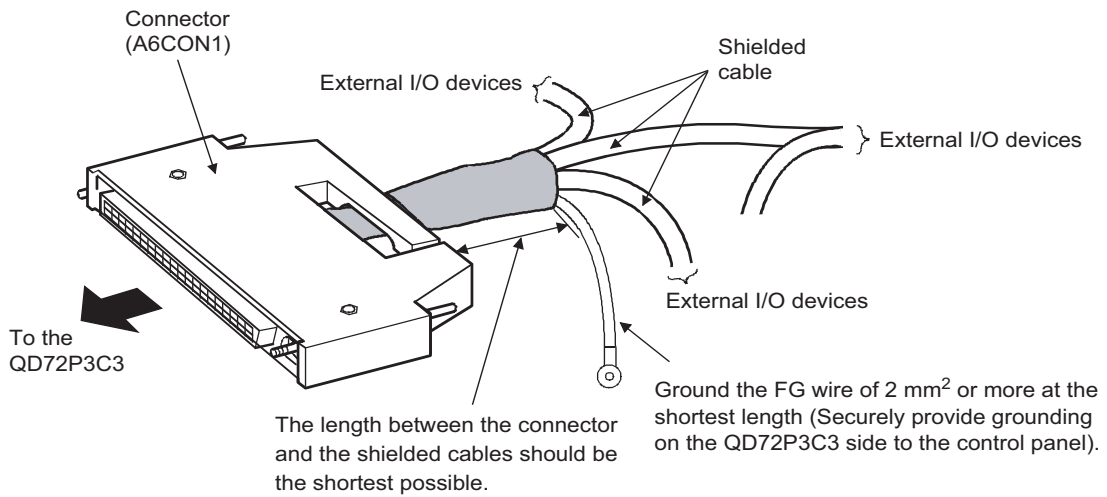

[When shielded cables are processed]

To protect the wires, cover the connector pins with the heat shrinkable insulation tubes.  
(Exposing the wires may cause a malfunction by the affect of static electricity.)

Take off the insulating tube of each shield and electrically connect the shields of the cables with conductive tapes.

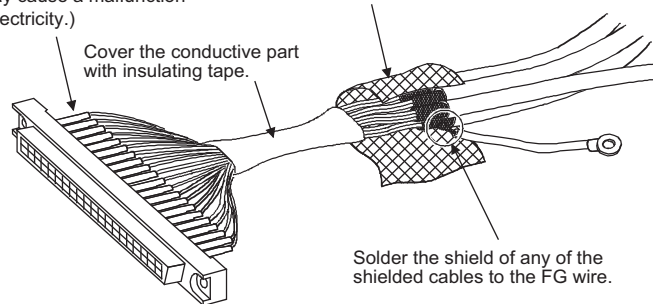



[When a duct is used (problematic example and modification example)]

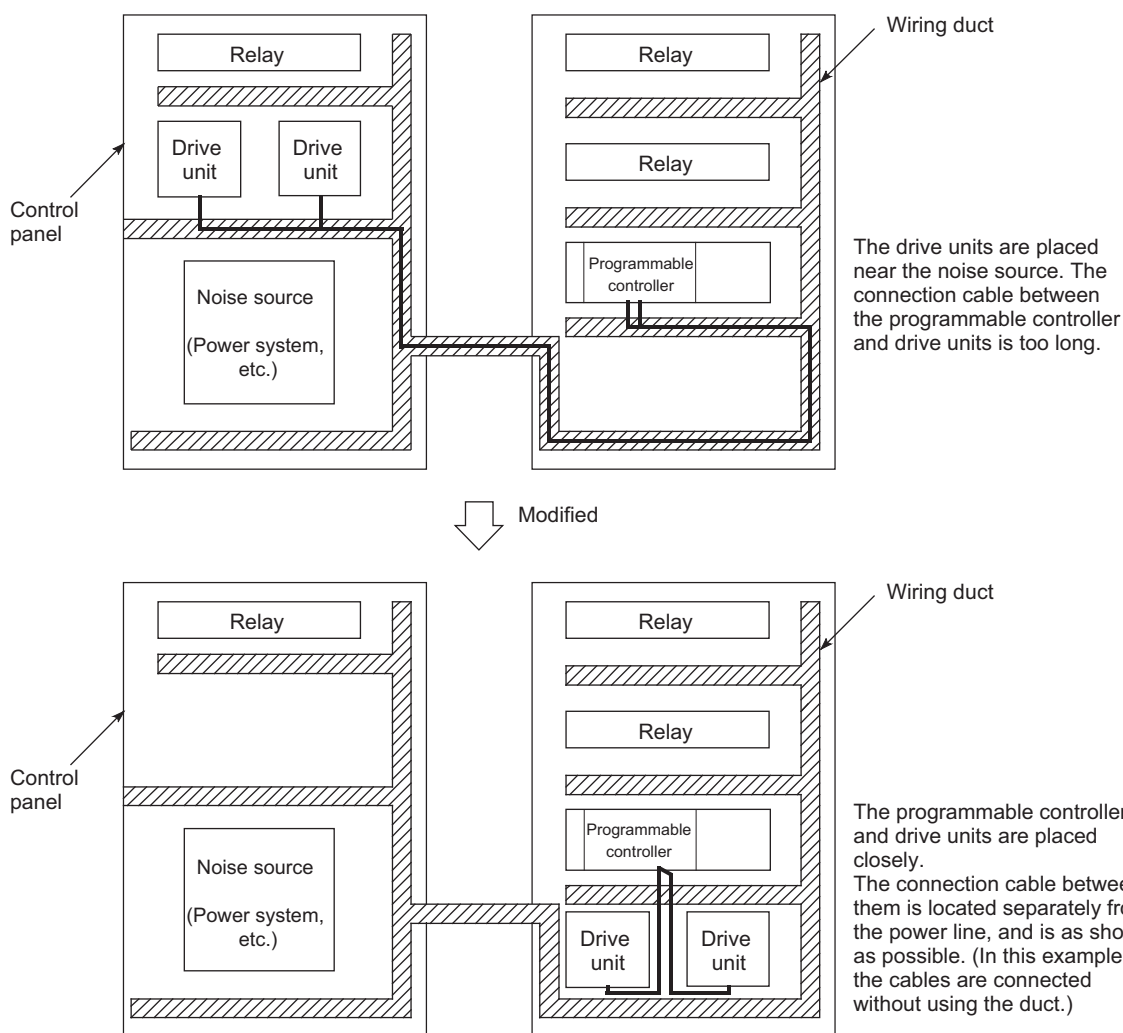

#### (f) I/O signal cables and other communication cables

As for the following, ground the shield of the cable (in the same way as explained in (a)) when it is extended out of the control panel.

- I/O signal cable (including common cable)

#### (g) Power cables for external power supply terminal

Use a reinforced or double insulated CE-marked external power supply for the following modules. Install an AC/DC power supply and a module inside the same control panel. Keep the length of the power cable connected to the external power supply terminal to 30m or less.

- Analog-digital converter module
- Digital-analog converter module
- Analog input/output module
- High-speed counter module
- Positioning module
- Temperature control module
- Flexible high-speed I/O control module

## **(5) External power supply**

Use a reinforced or double insulated CE-marked external power supply, and ground the FG terminal.  
(External power supply used for the tests conducted by Mitsubishi: DLP-120-24-1 (manufactured by TDK-Lambda Corporation), PS5R-SF24 (manufactured by IDEC Corporation))

## **(6) Power supply modules**

- Ground the LG and FG terminals after short-circuiting them.
- Use a CE-marked external power supply with a reinforced insulation or a double insulation to supply 24VDC to the L63SP.

## **(7) I/O modules**

- Install a DC power supply and an I/O module inside the same control panel.
- Use a shielded cable for the DC power when it is extended out of the control panel.
- Keep each DC power cable length to 30m or less.
- Take a surge protective measure, such as installing a surge suppressor, if the relay switches five times or more per minute.

## **(8) High-speed counter modules**

- Install a DC power supply and a high-speed counter module inside the same control panel.
- Use a shielded cable for the DC power when it is extended out of the control panel.
- Keep the length of cables connected to external devices to 30m or less.

## **(9) Positioning modules**

Install a DC power supply and a positioning module inside the same control panel.

## **(10) Temperature control modules**

Install a DC power supply and a temperature control module inside the same control panel.

## **(11) Flexible high-speed I/O control module**

Take following measures.

- Attach a ferrite core to the cable for the DC power connected to the flexible high-speed I/O control module, and to the cable for the DC power connected to a controller. For a ferrite core, the ESD-SR-250 (manufactured by NEC TOKIN Corporation) is recommended.
- Install the DC power in the same control panel where the module is installed.
- Use a shielded cable when a DC power cable is laid out of the control panel.
- The length of the cable connected to an output part or external devices must be 2m or less for open collector output, and 10m or less for differential output.
- The length of the cable connecting an input part and external devices must be 30m or less.

**(12)CC-Link modules**

- To ground the Ver.1.10-compatible CC-Link dedicated cable, refer to  Page 141, Appendix 9.1 (4) (c).
- Keep each power cable connected to the external power supply terminal or module power supply terminal to 30m or less.
- Connect a noise filter to the external power supply Use a noise filter with the damping characteristic, MA1206 (manufactured by TDK-Lambda Corporation) or equivalent. Note that a noise filter is not required if the module is used in Zone A defined in EN61131-2.
- Keep the length of signal cables connected to the analog input terminals of the following modules to 30m or less. Wire cables connected to the external power supply and module power supply terminal in the control panel where the module is installed.
  - AJ65BT-64RD3
  - AJ65BT-64RD4
  - AJ65BT-68TD
- For the cable connected to the power supply terminal of the AJ65SBT-RPS, AJ65SBT-RPG, or AJ65BT-68TD, install a ferrite core with the damping characteristics, ZCAT3035-1330 (manufactured by TDK Corporation) or equivalent. Wrap the cable around the ferrite core by one as shown below.

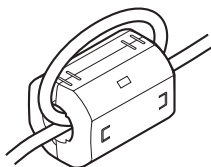

- To supply the module power supply terminal of the AJ65BTB2-16R/16DR, or AJ65SBTB2N-8A/8R/8S/16A/16R/16S with power using the AC/DC power supply, follow as shown below.
  - Install the AC/DC power supply in the control panel where the module is installed.
  - Use a reinforced or double insulated CE-marked AC/DC power supply, and ground the FG terminal. (AC/DC power supply used for the tests conducted by Mitsubishi: DLP-120-24-1 (manufactured by TDK-Lambda Corporation))
  - For the cable connected to the AC input terminal and DC output terminals of the AC/DC power supply, attach a ferrite core. Wrap the cable around the ferrite core by one as shown below. (Ferrite core used for the tests conducted by Mitsubishi: ESD-SR-250 manufactured by NEC TOKIN Corporation)

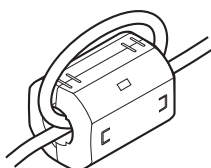

### (13)CC-Link/LT modules

- Use the module under the installation environment of Zone A\*<sup>1</sup>. For the specified Zones of the following products, refer to the manual provided with each product.
  - CL1Y4-R1B1                      • CL1Y4-R1B2                      • CL1XY4-DR1B2
  - CL1XY8-DR1B2                      • CL1PSU-2A
- To supply the CL2DA2-B and CL2AD4-B with power using the CL1PAD1, keep the length of the power cable connected from the CL1PAD1 to the external power supply to 30m or less.

\*1 Zone defines categories according to industrial environment, specified in the EMC and Low Voltage Directives, EN61131-2.

Zone C	Factory mains (isolated from public mains by dedicated transformer)
Zone B	Dedicated power distribution, secondary surge protection (rated voltage: 300V or less)
Zone A	Local power distribution, protected from dedicated power distribution by AC/DC converter and insulation transformer (rated voltage: 120V or less)

### (14)Others

#### (a) Ferrite core

A ferrite core is effective for reducing radiated noise in the 30MHz to 100MHz frequency band.

It is recommended to install a ferrite core if a shield cable extended out of the control panel does not provide sufficient shielding effects.

Install a ferrite core to the cable in the position just before the cable is extended out of the control panel. If the installation position is not appropriate, the ferrite core will not produce any effect.

Install a ferrite core to each power cable as shown below.

(Ferrite core used for the tests conducted by Mitsubishi: ESD-SR-250 manufactured by NEC TOKIN Corporation)

Example

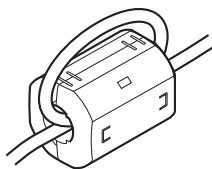

### (b) Noise filter (power supply line filter)

A noise filter is effective for reducing conducted noise in the 10MHz or less frequency band. (Use of a noise filter can suppress noise.)

The following are the installation precautions.

- Do not bundle the cables on the input side and output side of the noise filter. If bundled, the noise on the output side is induced into the filtered cable on the input side.

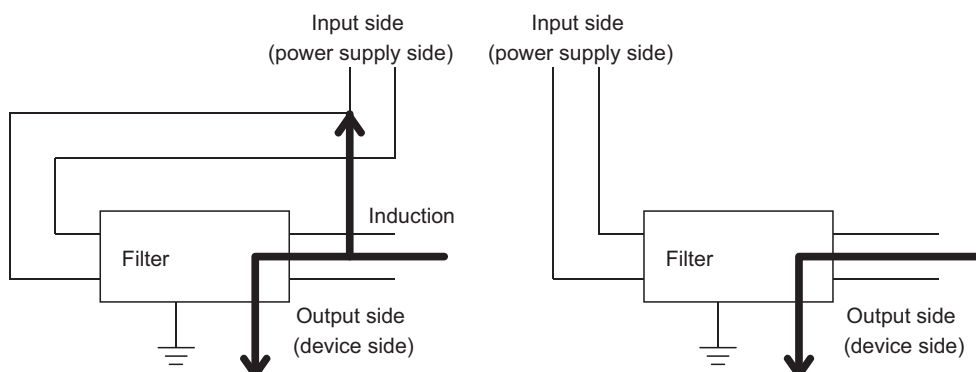

Noise will be induced when the input and output cables are bundled.

Separately install the input and output cables.

- Ground the ground terminal of the noise filter to the ground point of the control panel with the shortest cable possible (approximately 10cm).

### (c) Isolation transformer

An Isolation transformer is effective for reducing conducted noise (especially, lightning surge). Lightning surge may cause malfunction of the programmable controller. As measures against lightning surge, connect an isolation transformer as shown below. Use of an isolation transformer can reduce a lightning effect.

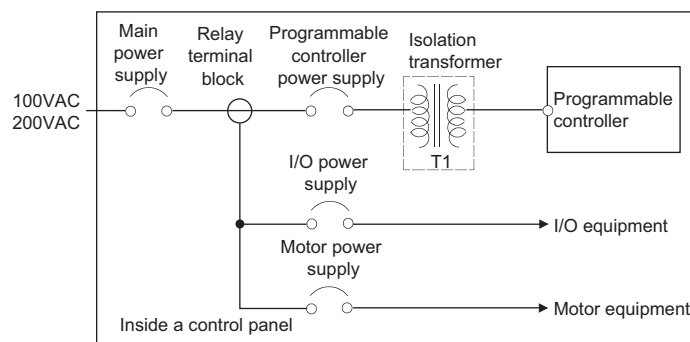

## Appendix 9.2 Measures to comply with the Low Voltage Directive

---

The Low Voltage Directive requires electrical equipment that is designed or adapted for use between 50 to 1000VAC or 75 to 1500VDC to satisfy the safety requirements.

This section describes the precautions for use of the MELSEC-L series modules to comply with the Low Voltage Directive.

These precautions are based on the requirements of the Low Voltage Directive and the harmonized standards. However, they do not guarantee that the entire machinery constructed according to the descriptions complies with the Low Voltage Directive. The manufacturer of the machinery must determine the testing method for compliance and declare conformity to the Low Voltage Directive.

### (1) Standard applied to MELSEC-L series modules

- EN61010-1 "Safety requirements for electrical equipment for measurement, control and laboratory use"

The MELSEC-L series modules that operate at 50VAC/75VDC or higher rated input voltage have also been developed in accordance with EN61010-1.

However, the modules which operate at less than 50VAC/75VDC rated input voltage are not targeted for the Low Voltage Directive compliance.

For CE-marked products, please consult your local Mitsubishi representative.

### (2) Selecting MELSEC-L series products

#### (a) Power supply modules

Power supply modules which operate at 100VAC or 200VAC rated input voltage have hazardous voltage (peak voltage higher than or equal to 42.4V) internally. Therefore, insulation between the primary and secondary circuits is reinforced for CE-marked power supply modules.

#### (b) I/O modules

I/O modules which operate at 100VAC or 200VAC rated input voltage have hazardous voltage (peak voltage higher than or equal to 42.4V) internally. Therefore, insulation between the primary and secondary circuits is reinforced for CE-marked I/O modules.

I/O modules which operate at 24VDC or less rated input voltage are not targeted for the Low Voltage Directive compliance.

#### (c) GOT

Use a CE-marked GOT.

#### (d) Products not subject to the Low Voltage Directive

The following products are not targeted for the Low Voltage Directive compliance because the circuits in the products operate at the voltage of 5VDC or less.

- Head module
- END cover

Intelligent function modules are also not targeted for the Low Voltage Directive compliance because the rated voltage of the modules is 24VDC or less.

### (3) Power supply

Power supply modules are designed to meet the overvoltage category II.

Confirm that the power supply to a programmable controller meets the overvoltage category II.

## (4) Control panel

### (a) Protection against electric shock

Handle the control panel as follows to protect a person who does not have adequate knowledge of electrical installation from an electric shock.

- Lock the control panel so that only a person who is trained and has acquired enough knowledge of electrical installation can open the panel.
- Design the control panel so that the power supply is automatically shut off when the panel is opened.
- Use a control panel with a protection degree of IP20 or higher.

### (b) Protection from dust and water

The control panel needs to be dustproof and waterproof.

Insufficient dustproof and waterproof lower the dielectric withstand of the control panel, possibly causing dielectric breakdown.

The insulation of Mitsubishi programmable controllers is designed to be used in an environment of pollution degree 2. Use them in an environment of pollution degree 2 or below. The environment of pollution degree 2 can be achieved when the programmable controller is installed inside the control panel with a protection degree of IP54 or equivalent.

## (5) External wiring

### (a) 24VDC external power supply

For 24VDC I/O modules or intelligent function modules requiring an external power supply, connect an external power supply of which insulation between the 24VDC circuit section and the hazardous voltage circuit section is reinforced.

### (b) External devices

For external devices connected to a programmable controller, use the one of which insulation between the interface circuit section to the programmable controller and the hazardous voltage circuit section is reinforced (if the device internally has a hazardous voltage circuit section).

### (c) Reinforced insulation

Reinforced insulation means an insulation having the following withstand voltage.

Rated voltage of hazardous voltage	Surge withstand voltage (1.2/50 $\mu$ s)
150VAC or less	2500V
300VAC or less	4000V

(Overvoltage category, source: IEC 664)

# Appendix 10 General Safety Requirements

---

When a programmable controller is powered on or off, normal control outputs may not be performed temporarily. This is because there is a time lag for the power to be turned on between the programmable controller power supply and the external power supply (especially, DC) for the control target. Normal control outputs also may not be performed when the external power supply or the programmable controller fails.

In terms of fail-safe and to prevent any of these abnormal operations from leading to the entire network system failure, configure safety circuits (such as emergency stop circuits, protection circuits, or interlock circuits, where abnormal operation may result in mechanical damage or accidents) external to the programmable controller.

## **(1) Fail-safe measures for head module failure**

A head module can detect its own hardware failures by the self-diagnostic function. However, failures which occur in a part, such as an I/O control part, may not be detected.

In this case, depending on the failure, all input or output points may turn on or off, or normal operation and safety of the control-target device may not be ensured.

Even though Mitsubishi programmable controllers are manufactured under strict quality control, they may fail due to some reasons. Provide fail-safe circuits external to the programmable controller so that no machine is damaged and no accident occurs.



## Appendix 11 Calculating Heating Value of Programmable Controller

The ambient temperature inside the control panel where a head module is installed must be 55°C or less.

It is necessary to know the average power consumption (heating value) of the equipment and devices installed inside the control panel when designing a heat release structure of the panel.

This section describes the calculation method of the average power consumption of a programmable controller system.

Calculate a rise in ambient temperature inside the control panel according to the power consumption.

### Appendix 11.1 Calculating the average power consumption

The total of the power consumption calculated for each block is the power consumption of the entire programmable controller system.

$$W = W_{PW} + W_{5V} + W_{24V} + W_{OUT} + W_{IN} + W_S \text{ (W)}$$

Calculate a heating value and a rise in ambient temperature inside the control panel according to the calculated power consumption (W).

The calculation formula for a rise in ambient temperature inside the control panel is as follows.

$$T = \frac{W}{UA} \text{ [}^\circ\text{C]}$$

W: Power consumption of the entire programmable controller system

A: Surface area inside the control panel [m<sup>2</sup>]

U (=6): When the ambient temperature inside the control panel is uniformed using a fan

U (=4): When the air inside the control panel is not circulated

#### Point

- If the temperature inside the control panel is expected to exceed the specified range, it is recommended to install a heat exchanger to the panel to lower the temperature.
- If a general-purpose fan is used, dust will be sucked into the control panel with the external air. This may affect the performance of the programmable controller.

The calculation formulas for the power consumption of each block are as follows.

### **(1) Power consumption of power supply module**

The power conversion efficiency of the power supply module is approximately 70% and 30% of the output power is consumed as heat. As a result, 3/7 of the output power will be the power consumption.

The calculation formula is as follows.

$$W_{PW} = \frac{3}{7} \times \{ (I_{5V} \times 5) + (I_{24V} \times 24) \} (W)$$

$I_{5V}$ : Current consumption of the 5VDC circuit of each module

$I_{24V}$ : Average current consumption of the 24VDC power supply for internal consumption of the output modules (power consumption for the output points simultaneously turned on)\*<sup>1</sup>

\*1 Not applicable for the power supply module which does not have the 24VDC power output. (Power (24VDC) is externally supplied.)

### **(2) Power consumption of the 5VDC logic circuit sections in all modules (including the head module)**

The power consumption of the 5VDC output circuit in the power supply module is the power consumption of each module.

$$W_{5V} = I_{5V} \times 5 (W)$$

### **(3) Total of 24VDC average power consumption of the output modules (power consumption for the output points simultaneously turned on)**

The average power of the 24VDC external power supply is the total power consumption of each module.

$$W_{24V} = I_{24V} \times 24 \times \text{Simultaneous on rate} (W)$$

### **(4) Voltage drop in the output section of the output module (power consumption for the output points simultaneously turned on)**

$$W_{OUT} = I_{OUT} \times V_{drop} \times \text{Number of output points} \times \text{Simultaneous on rate} (W)$$

$I_{OUT}$ : Output current (current in actual use) (A)

$V_{drop}$ : Voltage drop of each output module (V)

### **(5) Average power consumption of input section in the input module (power consumption for the input points simultaneously turned on)**

$$W_{IN} = I_{IN} \times E \times \text{Number of input points} \times \text{Simultaneous on rate} (W)$$

$I_{IN}$ : Input current (effective value for AC) (A)

E: Input voltage (voltage in actual use) (V)

### **(6) Power consumption of the external power supply section to the load(s) connected to the intelligent function module**

$$W_S = I_{24V} \times 24 (W)$$

## Appendix 12 Processing Time

The calculation formula for the I/O response time of the head module is as follows:

$$\text{Rio} = (\text{Number of RX/Ry points}) \times 0.16 + (\text{Number of RWw/RWr points}) \times 5.5 + 430 + \text{Ka} + (\text{Response time of the connected module}) [\mu\text{s}]$$

The above formula calculates the average value when the number of RX/Ry points is the same as the number of actual I/O points of the module connected to the head module, and an auto refresh of the same number of points as the number of RWw/RWr points was performed.

Rio	I/O response time of the head module
Number of RX/Ry points	The number of points set in "RX/Ry Setting" of Network Configuration Setting of the master station
Number of RWw/RWr points	The number of points set in "RWw/RWr Setting" of Network Configuration Setting of the master station
Ka	The value to add when auto refresh of the intelligent function module was performed = 140
Response time of the connected module	 Manual for the module used

### Point

To calculate the processing time of the CC-Link IE Field Network, add the I/O response time of the head module to the processing time of the slave stations.

For the processing time of the CC-Link IE Field Network, refer to the following.

 User's manual for the master/local module used

# Appendix 13 Added and Changed Functions

---

The following table lists added and changed functions.

Added function	Serial No. (first 5 digits) of the head module	GX Works2 version
Addition of applicable modules (positioning module and simple motion module) (  Page 35, Section 5.2)	"12072" or later	Version 1.31H or later
Indication of loopback execution by L ERR. LED	"12072" or later	—
Addition of a loopback detection feature for Connection status (own station) (SW0064)	"13032" or later	—

# Appendix 14 Checking Serial Number and Function Version

A

The serial number and function version of the head module can be checked on any of the following:

- Rating plate
- Front of the module
- System Monitor window in GX Works2

## (1) Checking on the rating plate

The rating plate is located on the side of the head module.

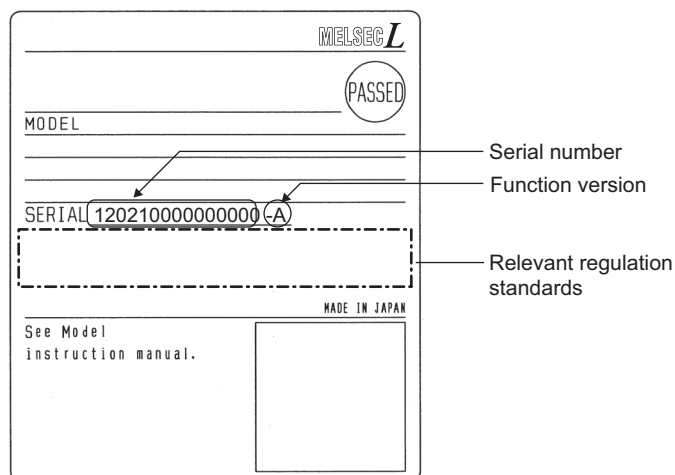

## (2) Checking on the front of the module

The serial number on the rating plate is printed on the front (at the bottom) of the module.

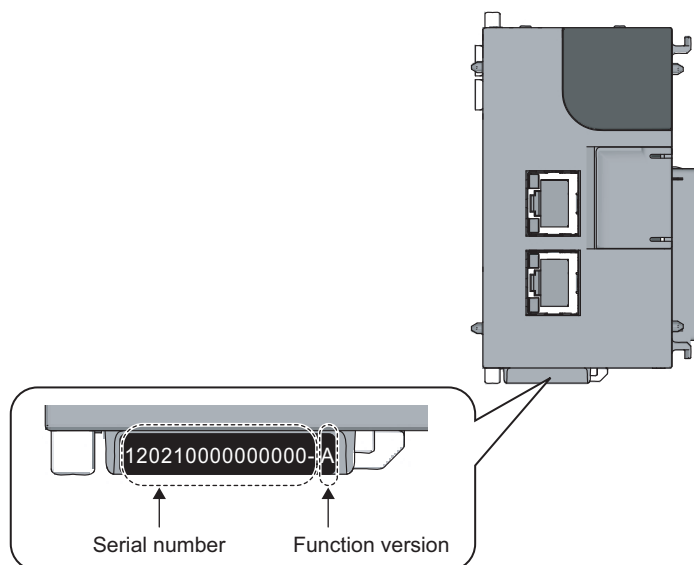

### (3) Checking on the System Monitor window

The serial number and function version can be checked on the "Product Information List" window.

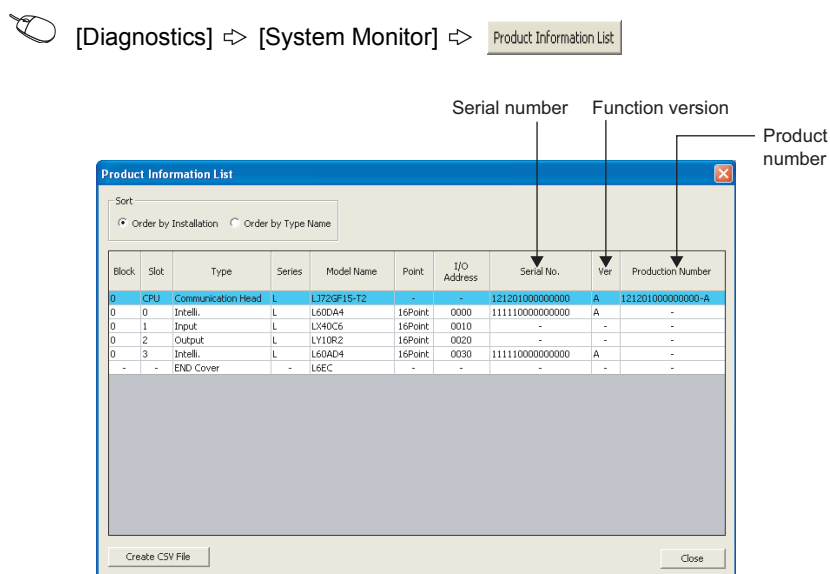

On the window, the serial number and function version of each intelligent function module can be checked as well.

The serial number of the module is displayed in the "Serial No." column.

The function version of the module is displayed in the "Ver" column.

If the module supports the production number display, the serial number (production number) printed on the rating plate of the module is displayed in the "Production Number" column.



The serial number displayed on the "Product Information List" window of GX Works2 may differ from that on the rating plate or on the front of the module.

- The serial number on the rating plate or on the front of the module indicates the management information of the product.
- The serial number displayed on the "Product Information List" window of GX Works2 indicates the functional information of the product. The functional information of the product is updated when a new function is added.

# Appendix 15 External Dimensions

**A**

## (1) Head module (LJ72GF15-T2)

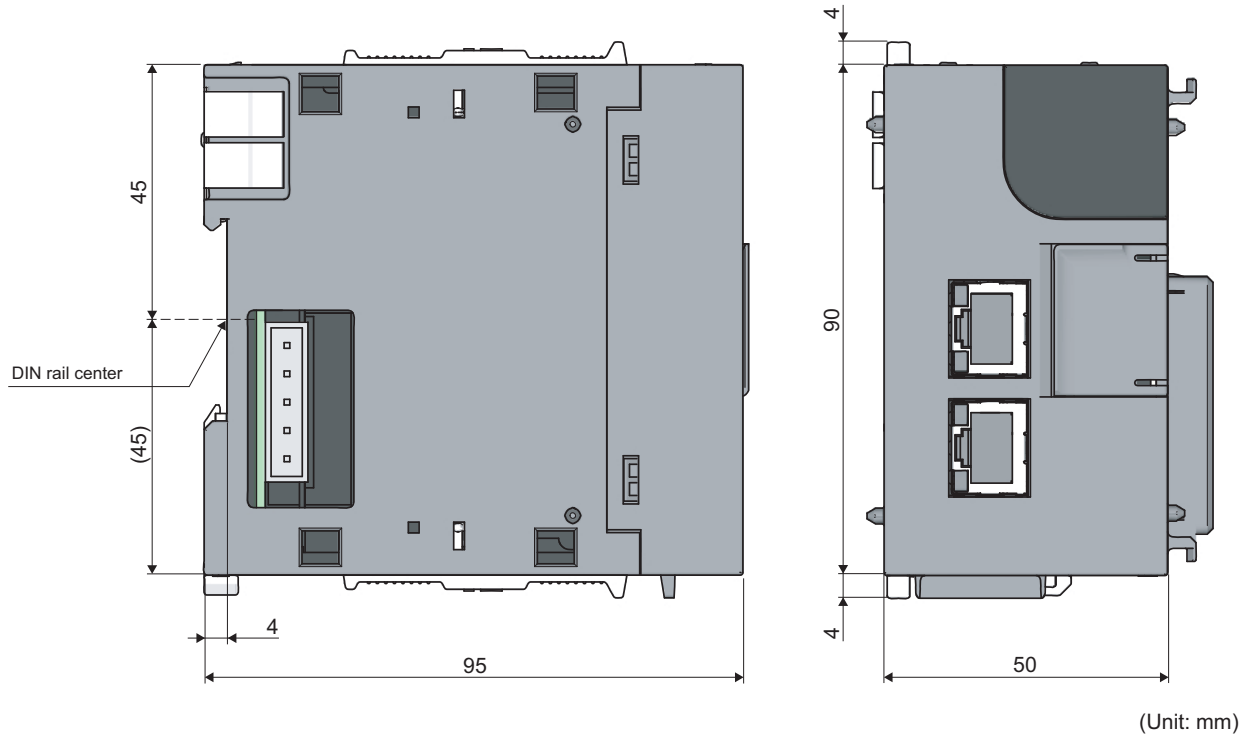

## (2) END cover (L6EC)

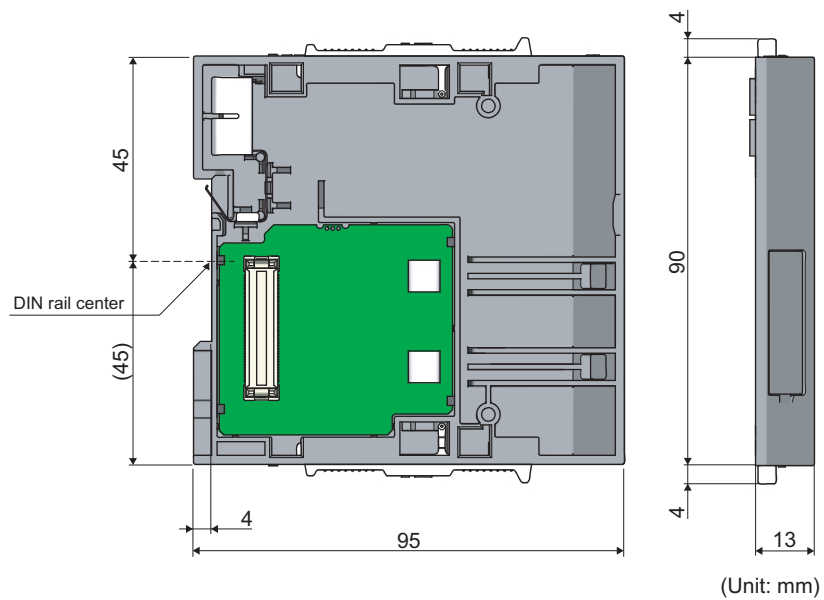

Appendix 15 External Dimensions

# INDEX

<b>A</b>	
Access code . . . . .	136
Applicable DIN rail models (IEC 60715) . . . . .	42
Applicable system . . . . .	35
Attribute code . . . . .	136
Auto refresh . . . . .	27
<b>B</b>	
Bending radius of the Ethernet cable . . . . .	50
<b>C</b>	
Cable clamp . . . . .	141
Cable test . . . . .	80
Calculating heating value of programmable controller . . . . .	151
Calculating the average power consumption . . . . .	151
CC-Link IE Field Network . . . . .	14
CC-Link IE Field Network diagnostics . . . . .	75
CE marking . . . . .	137
Changing modules on a DIN rail . . . . .	43
Checking for an error of a module other than the head module . . . . .	88
Checking for an error of the head module . . . . .	86
Checking serial number and function version . . . . .	155
Checking the error history . . . . .	89
Checking the LEDs . . . . .	91
Communication head setting . . . . .	53
Communication test . . . . .	80
Connectable modules and the number of modules . . . . .	35
Connecting an Ethernet cable . . . . .	47
Connecting modules . . . . .	38
Cyclic transmission . . . . .	14,17,28,65
<b>D</b>	
D LINK LED . . . . .	20
Daily inspection . . . . .	82
Data flow . . . . .	66,72
Data link . . . . .	14
Data setting method . . . . .	69,74
Dedicated instruction . . . . .	14
Device . . . . .	14
Diagnostic information . . . . .	127,129
Diagnostic items . . . . .	75
Diagnostic window . . . . .	78
Diagnostics . . . . .	28
DIN rail stopper . . . . .	42
Disconnection . . . . .	14
Drive information . . . . .	127,135
<b>E</b>	
EMC Directive . . . . .	137
Emission . . . . .	137
END cover . . . . .	121
ERR. LED . . . . .	21
Error codes (1 to 10000) . . . . . 97	
Error codes (D000H to DFFFH) . . . . . 103	
Error history . . . . . 53	
Error time output mode . . . . . 28,61	
External dimensions . . . . . 27,157	
External input/output forced on/off . . . . . 28	
<b>F</b>	
Fail-safe measures for head module failure . . . . . 150	
Ferrite core . . . . . 146	
File password 32 . . . . . 28,114	
Function list . . . . . 28	
<b>G</b>	
General safety requirements . . . . . 150	
General specifications . . . . . 24	
Grounding . . . . . 49	
<b>H</b>	
Head module . . . . . 14	
Head module system configuration . . . . . 34	
<b>I</b>	
I/O Assignment setting . . . . . 61	
I/O response time . . . . . 61	
Immunity . . . . . 138	
Initial setting . . . . . 27	
Installation . . . . . 37	
Installation and wiring . . . . . 36	
Installation environment . . . . . 36	
Installation position . . . . . 36	
Intelligent device station . . . . . 14	
Intelligent function module parameters . . . . . 64	
Internal current consumption (5VDC) . . . . . 27	
Interval between DIN rail mounting screws . . . . . 42	
Isolation transformer . . . . . 147	
<b>L</b>	
L ER LED . . . . . 21	
L ERR. LED . . . . . 21	
Laying Ethernet cables . . . . . 50	
Link dedicated instruction . . . . . 14	
Link device . . . . . 14	
LINK LED . . . . . 21	
Link special register (SW) . . . . . 14,123	
Link special relay (SB) . . . . . 14,122	
Local station . . . . . 14	
Low Voltage Directive . . . . . 148	
<b>M</b>	
Maintenance and inspection . . . . . 82	
Manual page organization . . . . . 13	



Master station . . . . .	14
Master/local module . . . . .	14
Maximum station-to-station distance . . . . .	50
Mode . . . . .	53
MODE LED . . . . .	20
Module error history collection (intelligent function module) . . . . .	56
Module replacement example . . . . .	33
Modules/unit that cannot be connected . . . . .	35
Monitoring/test . . . . .	28
Mounting the modules on a DIN rail . . . . .	40

## N

Network module . . . . .	14
Network number . . . . .	26,53
Network parameters . . . . .	62
Noise filter . . . . .	147
Number of device points . . . . .	27
Number of I/O points . . . . .	27

## O

Operation setting . . . . .	57
Operation test . . . . .	79
Output status for each status . . . . .	70
Overview . . . . .	17

## P

P1 . . . . .	21
P2 . . . . .	21
Packing list . . . . .	16
Parameter settings . . . . .	51
Part names . . . . .	20
Password authentication method . . . . .	119
Performance specifications . . . . .	26
Periodic inspection . . . . .	83
PLC name setting . . . . .	54
PLC operation mode at H/W error . . . . .	28,61
PLC parameters . . . . .	52
PLC RAS setting . . . . .	56
PLC system setting . . . . .	55
Procedure for replacing the head module . . . . .	31
Procedures before operation . . . . .	29
Processing time . . . . .	153
Programming tool . . . . .	14

## R

RD LED . . . . .	20
Reinforced insulation . . . . .	149
Relay station . . . . .	14
Relevant manuals . . . . .	9
REM. LED . . . . .	20
Remote device station . . . . .	14
Remote I/O station . . . . .	14
Remote input (RX) . . . . .	14
Remote operation . . . . .	81
Remote output (RY) . . . . .	15
Remote password . . . . .	28,63
Remote register (RW <sub>r</sub> ) . . . . .	15
Remote register (RW <sub>w</sub> ) . . . . .	15

Remote RESET . . . . .	28,55
Remote RUN/STOP . . . . .	28
Reserved station . . . . .	15
RESET/TEST . . . . .	22
Return . . . . .	15
Routing . . . . .	15
RUN . . . . .	22
RUN LED . . . . .	20

## S

Safety precautions . . . . .	1
SD LED . . . . .	20
Selected station communication status monitor . . . . .	79
Selected station operation . . . . .	79
Serial number display . . . . .	21
Setting file passwords . . . . .	115
Slave station . . . . .	15
Software package . . . . .	35
Special register (SD) . . . . .	128
Special relay (SM) . . . . .	126
Specifications . . . . .	24
Station number . . . . .	26,53
Station number setting from the master station . . . . .	28
STOP . . . . .	22
Switch . . . . .	22
System clock/counter . . . . .	127
System configuration . . . . .	34
System error history . . . . .	28,53,89
System information . . . . .	133
System monitor . . . . .	81

## T

Terms . . . . .	14
Testing the head module before wiring . . . . .	45
Transient transmission . . . . .	15,18,28
Troubleshooting . . . . .	84
Troubleshooting by symptom . . . . .	95
Troubleshooting procedure . . . . .	84

## U

Unit test . . . . .	45
---------------------	----

## W

Weight . . . . .	27
When cyclic transmission cannot be performed . . . . .	95
When the D LINK LED flashes . . . . .	92
When the D LINK LED turns off . . . . .	92
When the ERR. LED turns on . . . . .	92
When the L ERR. LED turns on . . . . .	93
When the LINK LED turns off . . . . .	93
When the MODE LED flashes . . . . .	91
When the MODE LED turns off . . . . .	91
When the REM. LED flashes . . . . .	93
When the REM. LED turns off . . . . .	94
When the RUN LED flashes . . . . .	91
When the RUN LED turns off . . . . .	91
When transient transmission cannot be performed . . . . .	95
Wiring to the head module . . . . .	47
Wiring to the power supply module . . . . .	45

# REVISIONS

\*The manual number is given on the bottom left of the back cover.

Print date	*Manual number	Revision
April 2010	SH(NA)-080919ENG-A	First edition
September 2010	SH(NA)-080919ENG-B	<p><b>Partial correction</b></p> <p>Chapter 2, Section 3.2, 5.2, 6.5.1, 8.1, 11.4, 11.6, Appendix 5, 11</p> <p><b>Addition</b></p> <p>Appendix 12</p> <p><b>Chapter change</b></p> <p>Appendix 12 → 13, Appendix 13 → 14</p>
May 2011	SH(NA)-080919ENG-C	<p><b>Partial correction</b></p> <p>Section 3.2, 4.2, 5.2, 8.1, 8.2, 11.6, Appendix 5, 12</p>
November 2011	SH(NA)-080919ENG-D	<p><b>Addition</b></p> <p>Appendix 9</p> <p><b>Chapter change</b></p> <p>Appendix 9 to 14 → Appendix 10 to 15</p>
September 2012	SH(NA)-080919ENG-E	<p><b>Partial correction</b></p> <p>SAFETY PRECAUTIONS, TERM, Chapter 1, Section 3.1, 3.2, 6.2.1, 6.2.3, 6.5.1, 7.4, 8.1, 8.2, 11.6, Appendix 4, 9.2</p>
February 2013	SH(NA)-080919ENG-F	<p><b>Partial correction</b></p> <p>Section 5.2, 6.2.2, 8.1, 8.2, 9.1 to 9.3, 9.5, 9.6, Appendix 7, 9.1</p>
July 2013	SH(NA)-080919ENG-G	<p><b>Partial correction</b></p> <p>Section 5.2, 8.1, Appendix 9.1</p>
October 2014	SH(NA)-080919ENG-H	<p><b>Partial correction</b></p> <p>Section 6.5.2</p>
October 2015	SH(NA)-080919ENG-I	<p><b>Partial correction</b></p> <p>Section 5.2</p>
March 2017	SH(NA)-080919ENG-J	<p><b>Partial correction</b></p> <p>INTRODUCTION, RELEVANT MANUALS, TERMS, PACKING LIST, Chapter 2, Section 3.2, 5.1, 5.2, 6.2, 6.2.1, 7.3, 11.4, Appendix 2.2, 9, 9.1, 9.2, 14, 15</p>

Japanese manual version SH-080918-J

This manual confers no industrial property rights or any rights of any other kind, nor does it confer any patent licenses. Mitsubishi Electric Corporation cannot be held responsible for any problems involving industrial property rights which may occur as a result of using the contents noted in this manual.

© 2010 MITSUBISHI ELECTRIC CORPORATION

# WARRANTY

Please confirm the following product warranty details before using this product.

## **1. Gratis Warranty Term and Gratis Warranty Range**

If any faults or defects (hereinafter "Failure") found to be the responsibility of Mitsubishi occurs during use of the product within the gratis warranty term, the product shall be repaired at no cost via the sales representative or Mitsubishi Service Company.

However, if repairs are required onsite at domestic or overseas location, expenses to send an engineer will be solely at the customer's discretion. Mitsubishi shall not be held responsible for any re-commissioning, maintenance, or testing on-site that involves replacement of the failed module.

[Gratis Warranty Term]

The gratis warranty term of the product shall be for one year after the date of purchase or delivery to a designated place. Note that after manufacture and shipment from Mitsubishi, the maximum distribution period shall be six (6) months, and the longest gratis warranty term after manufacturing shall be eighteen (18) months. The gratis warranty term of repair parts shall not exceed the gratis warranty term before repairs.

[Gratis Warranty Range]

- (1) The range shall be limited to normal use within the usage state, usage methods and usage environment, etc., which follow the conditions and precautions, etc., given in the instruction manual, user's manual and caution labels on the product.
- (2) Even within the gratis warranty term, repairs shall be charged for in the following cases.
  1. Failure occurring from inappropriate storage or handling, carelessness or negligence by the user. Failure caused by the user's hardware or software design.
  2. Failure caused by unapproved modifications, etc., to the product by the user.
  3. When the Mitsubishi product is assembled into a user's device, Failure that could have been avoided if functions or structures, judged as necessary in the legal safety measures the user's device is subject to or as necessary by industry standards, had been provided.
  4. Failure that could have been avoided if consumable parts (battery, backlight, fuse, etc.) designated in the instruction manual had been correctly serviced or replaced.
  5. Failure caused by external irresistible forces such as fires or abnormal voltages, and Failure caused by force majeure such as earthquakes, lightning, wind and water damage.
  6. Failure caused by reasons unpredictable by scientific technology standards at time of shipment from Mitsubishi.
  7. Any other failure found not to be the responsibility of Mitsubishi or that admitted not to be so by the user.

## **2. Onerous repair term after discontinuation of production**

- (1) Mitsubishi shall accept onerous product repairs for seven (7) years after production of the product is discontinued. Discontinuation of production shall be notified with Mitsubishi Technical Bulletins, etc.
- (2) Product supply (including repair parts) is not available after production is discontinued.

## **3. Overseas service**

Overseas, repairs shall be accepted by Mitsubishi's local overseas FA Center. Note that the repair conditions at each FA Center may differ.

## **4. Exclusion of loss in opportunity and secondary loss from warranty liability**

Regardless of the gratis warranty term, Mitsubishi shall not be liable for compensation to:

- (1) Damages caused by any cause found not to be the responsibility of Mitsubishi.
- (2) Loss in opportunity, lost profits incurred to the user by Failures of Mitsubishi products.
- (3) Special damages and secondary damages whether foreseeable or not, compensation for accidents, and compensation for damages to products other than Mitsubishi products.
- (4) Replacement by the user, maintenance of on-site equipment, start-up test run and other tasks.

## **5. Changes in product specifications**

The specifications given in the catalogs, manuals or technical documents are subject to change without prior notice.

## TRADEMARKS

Ethernet is a registered trademark of Fuji Xerox Co., Ltd. in Japan.

The company names, system names and product names mentioned in this manual are either registered trademarks or trademarks of their respective companies.

In some cases, trademark symbols such as <sup>™</sup> or <sup>®</sup> are not specified in this manual.



SH(NA)-080919ENG-J(1703)MEE

MODEL: LJ72GF15-T2-U-E

MODEL CODE: 13JZ48

## **MITSUBISHI ELECTRIC CORPORATION**

HEAD OFFICE : TOKYO BUILDING, 2-7-3 MARUNOUCHI, CHIYODA-KU, TOKYO 100-8310, JAPAN  
NAGOYA WORKS : 1-14, YADA-MINAMI 5-CHOME, HIGASHI-KU, NAGOYA, JAPAN

When exported from Japan, this manual does not require application to the  
Ministry of Economy, Trade and Industry for service transaction permission.

Specifications subject to change without notice.